



Oil Moisture Sensor

BCM-W

Installation and Operation Instructions

Original instructions





Bühler Technologies GmbH, Harkortstr. 29, D-40880 Ratingen
Tel. +49 (0) 21 02 / 49 89-0, Fax: +49 (0) 21 02 / 49 89-20
Internet: www.buehler-technologies.com
E-Mail: fluidcontrol@buehler-technologies.com

Read this instruction carefully prior to installation and/or use. Pay attention particularly to all advises and safety instructions to prevent injuries. Bühler Technologies can not be held responsible for misusing the product or unreliable function due to unauthorised modifications.

All rights reserved. Bühler Technologies GmbH 2021

Document information

Document No.....BE150101
Version..... 12/2021

Contents

1	Introduction.....	2
1.1	Intended Use.....	2
1.2	Functionality.....	2
1.2.1	Humidity monitoring.....	2
1.2.2	Temperature monitor.....	2
1.2.3	IO-Link.....	2
1.3	Design types.....	3
1.4	Model key.....	3
1.5	Scope of Delivery.....	3
2	Safety instructions.....	4
2.1	Important advice.....	4
2.2	General hazard warnings.....	5
3	Transport and storage.....	6
4	Setup and connection.....	7
4.1	Installation.....	7
4.1.1	Installation recommendation.....	8
4.2	Electrical connections.....	8
5	Operation and Control.....	9
5.1	BCM-WD/BCM-WR.....	9
5.1.1	Start-up procedure.....	9
5.1.2	LED statuses.....	9
5.1.3	General key functions.....	10
5.1.4	Keylock enabled.....	10
5.1.5	Menu overview.....	11
5.1.6	Changing basic settings.....	12
5.1.7	Switching outputs.....	15
5.1.8	Analogue outputs.....	20
5.1.9	Diagnostic options.....	22
5.2	BCM-WS.....	25
5.2.1	Start-up procedure.....	25
5.2.2	Parameter configuration.....	25
5.2.3	Factory setting.....	25
5.2.4	Switching outputs.....	25
5.2.5	Analogue outputs.....	25
6	Cleaning and Maintenance.....	26
7	Service and repair.....	27
7.1	Removal information.....	27
7.2	Troubleshooting.....	27
7.3	Spare parts and accessories.....	28
8	Disposal.....	29
9	Appendices.....	30
9.1	Technical Data BCM-WS.....	30
9.2	Technical Data BCM-WR/BCM-WD.....	32
9.3	Dimensions BCM-WS.....	33
9.4	Outputs BCM-WS.....	34
9.5	Outputs BCM-WD/BCM-WR.....	34
9.6	Pin assignment BCM-WS.....	34
9.7	Pin assignment BCM-WR/WD.....	35
9.8	Display ranges.....	35
9.9	Current settings.....	35
9.10	Menu Sequence Overview.....	36
10	Attached documents.....	37

1 Introduction

1.1 Intended Use

Oil moisture sensors are used to monitor the water content in oils and the temperature. Oil moisture sensors must not be used in highly flammable or corrosive liquids.

Please note the technical data in the appendix for the specific intended use, existing material combinations, as well as temperature limits.

WARNING



All device models are solely intended for industrial applications. They are **not safety components**. The devices must not be used if failure or malfunction thereof jeopardises the safety and health of persons. Use in explosive areas is **prohibited**.

1.2 Functionality

The sensor determines the relative humidity in oil through water activity (a_w). The relative humidity behaves similar to water activity. Here we can also use the term saturation level of oil. The sensor features a measuring chamber where humid air on the inside and humidity in the medium become balanced. This puts the sensor in relation to the maximum saturation. So it provides a degree of the saturation of the oil. Furthermore, the temperature is determined to allow for correcting the values. The water activity is specified as a factor from 0 to 1. When multiplied by 100% this provides the relative humidity or the saturation in percent.

The critical limit for saturation depends on several parameters specific to the system. The main advantage, however, is the continuous monitoring of humidity and temperature. The operating company can therefore make their own determinations on changes in his system and adjust system parameters where necessary.

1.2.1 Humidity monitoring

The sensor element for determining the humidity is located inside the medium, protected by a tube. The relative humidity can be continuously output as analog signal or digital signal (IO-Link) or as a switch signal. The threshold is preset and can be configured depending on the model. Depending on the version, there are several switching outputs combined with one analog output (4 - 20 mA). The display versions can show the relative humidity in the display and output it to the analog output. The thresholds for the switching outputs can be freely configured. The sensor versions have the option for analogue output of the relative humidity. The threshold for the switching point is preset and can only be factory configured or via the digital interface.

1.2.2 Temperature monitor

The temperature is monitored via temperature sensor (Pt100) inside the medium, protected by a tube. Depending on the version, there are several switching outputs combined with one analog output (4 - 20 mA) or digital output (IO-Link). The display types can display the temperature and output it to the analog output. The sensor types have the option for analogue temperature output.

Please note the technical data in the appendix.

1.2.3 IO-Link

If the sensor has an IO-Link interface, the identification, process and diagnostics data can be accessed. The sensor parameters such as switching points or switch-back points can be set during operation. This requires an IO-Link Master with configuration tool.

When replacing the sensor all previously configured parameters can be transferred to the new sensor.

The sensor has an electronic technical manual, the so-called IODD file. The IODD file contains all information required for system integration. The file can be downloaded from <https://ioddfinder.io-link.com>.

For more information please visit: www.io-link.com



1.3 Design types

The BCM is available as three basic models:

Model	Description
BCM-WS	Sensor without display
BCM-WD	Sensor with display (display built into the sensor)
BCM-WR	Combination of sensor and display (display for external installation)

The BCM will have different switching and analogue outputs depending on the configuration. The outputs are freely programmable.

The sensor versions are available with digital interface. Here the sensor uses the standardised technology **IO-Link**, an efficient point-to-point communication. It uses the previous, proven and tested connection technology. Compatibility with the previous technology is guaranteed.

1.4 Model key

Model BCM-WS

BCM - W S 1 **0 -** /

<p>Type designation BCM Moisture Sensor</p>		
<p>W Humidity</p>	<p>Version S Sensor</p>	<p>Length (only model WS160)</p>
<p>Process connection 0 G3/4 2 G1/2 6 Flange (per DIN 24557/T2)</p>	<p>Outputs 1S2A 1x switching output / 2x analog 1D Version IO-Link</p>	

Model BCM-WD/BCM-WR

BCM - W **10** **0 -**

<p>Type designation BCM Moisture Sensor</p>		
<p>W Humidity</p>	<p>Version D Display with built-in sensor R Remote display with external sensor</p>	<p>Outputs 2S2A 2 x switching output / 2 x analogue 1D1S 1 x switching output / IO-Link 4S2A 4 x switching output / 2 x analogue</p>
	<p>Process connection 0 G 3/4 2 G 1/2</p>	

1.5 Scope of Delivery

- BCM Oil Moisture Sensor
- Product documentation
- Connection/mounting accessories (optional)

2 Safety instructions

2.1 Important advice

This device may only be used if:

- The product is being used under the conditions described in the operating- and system instructions, used according to the nameplate and for applications for which it is intended. Any unauthorized modifications to the device will void the warranty provided by Bühler Technologies GmbH,
- the specifications and markings in the type plate are observed,
- the limits in the data sheet and the instructions must be observed,
- monitoring equipment / protection devices must be connected correctly,
- the device is protected from mechanical damage and vibration,
- service and repairs not described in these instructions is performed by Bühler Technologies GmbH,
- using genuine replacement parts.

These operating instructions are a part of the equipment. The manufacturer reserves the right to change performance-, specific- or technical data without prior notice. Please keep these instructions for future reference.

Signal words for warnings

DANGER	Signal word for an imminent danger with high risk, resulting in severe injuries or death if not avoided.
WARNING	Signal word for a hazardous situation with medium risk, possibly resulting in severe injuries or death if not avoided.
CAUTION	Signal word for a hazardous situation with low risk, resulting in damaged to the device or the property or minor or medium injuries if not avoided.
NOTICE	Signal word for important information to the product.

Warning signs

These instructions use the following warning signs:

	Warns of a general hazard		Unplug from mains
	Voltage warning		Wear respiratory equipment
	Warns not to inhale toxic gasses		Wear a safety mask
	Warns of corrosive liquids		Wear gloves
	General information		

2.2 General hazard warnings

The equipment must be installed by a professional familiar with the safety requirements and risks.

Be sure to observe the safety regulations and generally applicable rules of technology relevant for the installation site. Prevent malfunctions and avoid personal injuries and property damage.

The operator of the system must ensure:

- Safety notices and operating instructions are available and observed,
- The respective national accident prevention regulations are observed,
- The permissible data and operational conditions are maintained,
- Safety guards are used and mandatory maintenance is performed,
- Legal regulations are observed during disposal,
- compliance with national installation regulations.

Maintenance, Repair

Please note during maintenance and repairs:

- Repairs to the unit must be performed by Bühler authorised personnel.
- Only perform conversion-, maintenance or installation work described in these operating and installation instructions.
- Always use genuine spare parts.
- Do not install damaged or defective spare part. If necessary, visually inspect prior to installation to determine any obvious damage to the spare parts.

Always observe the applicable safety and operating regulations in the respective country of use when performing any type of maintenance.

The method for cleaning the devices must be adapted to the IP protection class of the devices. Do not use cleaners which could damage the device materials.

DANGER



Toxic, acidic gases/liquids

Protect yourself from toxic, corrosive gasses/liquids when performing any type of work.
Wear appropriate protective equipment.



3 Transport and storage

Only transport the product inside the original packaging or a suitable alternative.

The equipment must be protected from moisture and heat when not in use. It must be stored in a covered, dry, dust-free room at room temperature.

4 Setup and connection

DANGER

Electric voltage



Risk of electric shock

- a) De-energise the system.
- b) The equipment may only be installed, maintained and put into operation by instructed, competent personnel.
- c) Always observe the applicable safety regulations for the operating site.



DANGER

Toxic, acidic gases/liquids



Protect yourself from toxic, corrosive gasses/liquids when performing any type of work. Wear appropriate protective equipment.



CAUTION

Overpressure



Protect the device from static and dynamic overpressures. Use suitable preventive measures!

4.1 Installation

Before installing the device, ensure the system is depressurised to prevent liquid from escaping. If necessary, use a collection container.

The BCM comes fully assembled and can be installed in the piping flange connection on a tank housing using the screw-in thread. When doing so, please ensure the sensor part is always fully bathed by medium to ensure the measured values displayed are correct. For built-in versions, use the flow cell, sold separately.

DANGER

Electric voltage



Risk of electric shock

When connecting devices, please note the maximum voltages and currents (see technical data) and use the correct wire cross-sections and circuit breakers. When selecting the connection lines, also note the maximum operating temperatures of the devices.



The flange-mounted display units can be swivelled vertically by approx. 270° so they are easier to read. Please note the built-in swivel stop. You will notice more resistance when reaching the stop. Turning it beyond this stop may damage the display unit.

4.1.1 Installation recommendation

Proper moisture sensor function requires the entire sensor element to be inside the medium at all times. The sensor version is suitable for installation at the side of the tank. Here the installation position should be below the minimum liquid level. When installing into a return pipe, be sure not to exceed the maximum flow rate.

With the BCM-WR version the remote display mounts to a top hat rail.

Installation example:

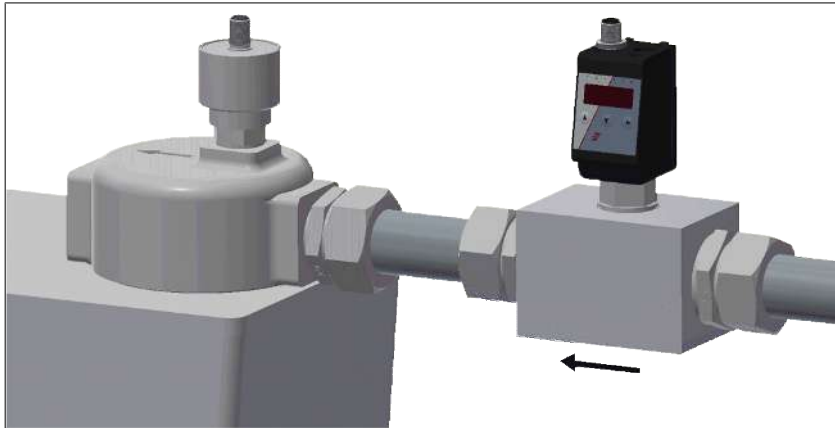

Assembly block dimensions:

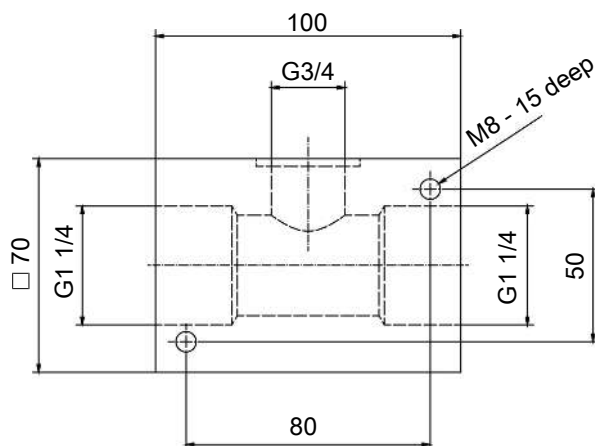

4.2 Electrical connections

Electricity is supplied via plug connectors. Please refer to the appendix for installation dimensions, nominal voltage and plug configuration.

The switching outputs are PNP transistors (see illustration):

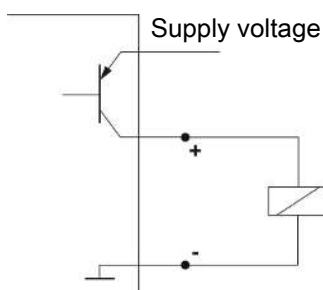

Note: When measuring the switching output with high-load measuring device inputs or when used as a frequency output, the load must be set to 10 kΩ between the output and earth (GND) to avoid faulty measurements.

5 Operation and Control

NOTICE



The device must not be operated beyond its specifications.

5.1 BCM-WD/BCM-WR

This explanation of operation refers to the versions with display unit.

5.1.1 Start-up procedure

The device will automatically switch on when connected to power. It will first briefly display the software version, at which time the device will also check the built-in components. The display will then switch to displaying measurements.

The following describes the function of the display and control unit:

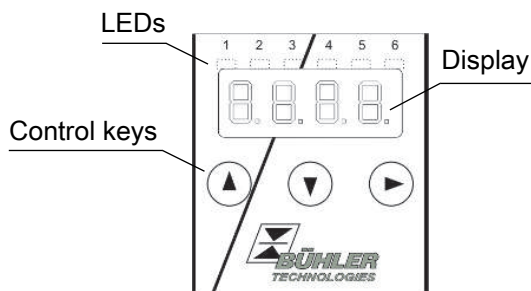

If an error message appears in the display during operation, please refer to the **Troubleshooting** table under chapter “Service and Repair”.

5.1.2 LED statuses

LEDs above the measurement display indicate the status of the switching outputs. The LEDs are permanently assigned to the switching outputs.

The following table lists the factory settings for the liquid level and temperature switching output configuration:

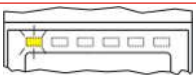
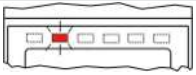
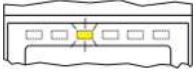
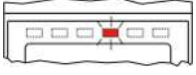
		2 switching outputs	4 switching outputs
	LED 1 – yellow Status switching output 1	Humidity	Humidity
	LED 2 - red Status switching output 2	Temperature	Humidity
	LED 3 – yellow Status switching output 3	---	Temperature
	LED 4 – red Status switching output 4	---	Temperature

The switching characteristics of the LED (on if switching contact closed or open) can be changed.

5.1.3 General key functions

The keys below the display are used for operation.

The menu controls are detailed in the following chapters.

Key	Mode	Function
▶	- Measurement display:	Change measured variables displayed.
	- In the menu:	Move down one menu level. Move up one menu level.
	- At the end of the menu:	 The display indicates the end of the menu.
	- Following input/selection:	Confirm and save a numerical value entered or a function selection. The display will flash if a parameter has been changed.
▲	- Measurement display:	Displays the configuration.
	- In the menu:	Scroll up menu item, numerical value or function selection. Holding the key will continuously scroll.
▼	- Measurement display:	Go to main menu.
	- In the menu:	Scroll down menu item, numerical value or function selection. Holding the key will continuously scroll.
▼ + ▶	- In the menu:	Exit the main / sub / drop-down menu and return to displaying the measurement without saving changes to the parameters.
▲ + ▶	- In the menu:	Move to the next higher menu level.
60 s no action	- In the menu:	Exit the main / sub/ drop-down menu.

To select a menu item and to enter values:

- Open the main menu with the ▼ key.
- Select the submenu with the ▼ and ▲ keys and open the submenu with the ▶ key.
- If necessary, select the next submenu with the ▼ and ▲ keys and open with the ▶ key.
- Select the desired menu item with the ▼ and ▲ keys and open the list of values with the ▶ key.
- Set the value with the ▼ and ▲ keys and confirm with the ▶ key. The new settings will be saved and the device will return to the submenu.
- Select the menu item EXIT to exit the submenu and confirm with the ▶ key. The device will return to the next menu level up or to the measurement display.

5.1.4 Keylock enabled

With the keylock enabled, selecting the menu with the ▼ key will display  in place of the main menu. The active digit will be indicated by a dot.

- Use the ▲ and ▼ keys to enter the code and confirm with the ▶ key. The active digit will move one place to the right. After entering the 3rd digit the main menu will open.

If the wrong code is entered, the device will return to the measurement display. If you forgot the password you can always enter master code 287 to access the menu.

You can cancel the keylock under *Loc* in submenu **Basic Settings Advanced Options** *bEF* and enter 000 to reset the code.

5.1.5 Menu overview

The menu structure is based on the VDMA standard sheet 24574-1. The menu structure is hierarchic. The top menu level contains the main menu items, e.g. *HuPi*, *tENP*, *bEF*, *d.R*, *E*. Each main menu contains further submenu items.

The menu items may vary depending on the device configuration. Not all menu items described below will necessarily apply to your device. Press the ▲ key in display mode to open the configuration. A 4-digit code will appear, e.g.

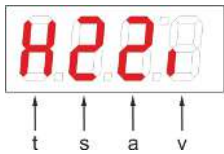

With the 4 digits tsav meaning:

t: Model

s: Number of switching outputs

a: Number of analogue outputs

v: Device installation type

h = humidity and temperature measurement

2 or 4

0 of the 2

i = standard installation (tank installation)

r = remote installation

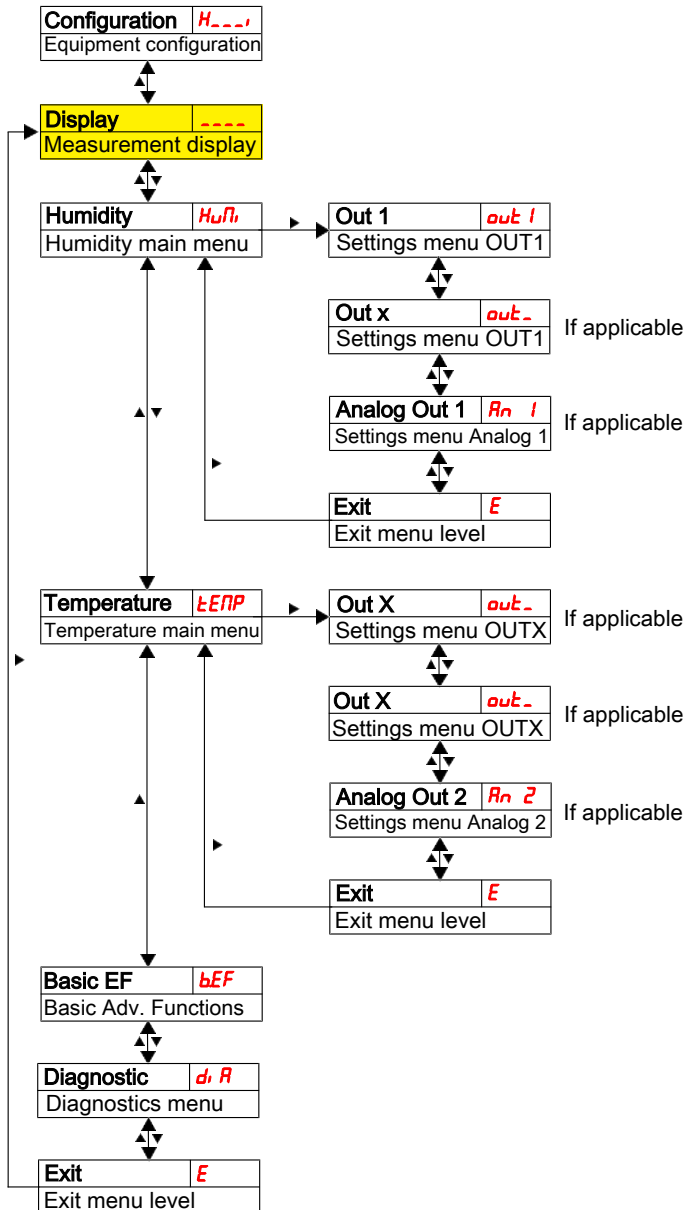

The individual menu items will not be shown if the option does not apply. Example: With a=0 the menu items for configuring the analogue output does not apply. You can then skip the description for this item.

The structure of the main menus **Humidity** (*HuPi*) and **Temperature** (*tENP*) is identical. Here you can configure the switching outputs or the analogue outputs (if applicable).

The basic device settings can be changed. General settings can be configured under **Basic Settings Advanced Functions (bEF)**. These settings should be configured first, as they affect the displays and settings for the individual menus. These settings are e.g. the units used and allocating switching outputs for liquid level and temperature measurement. The allocation of the analogue outputs cannot be changed.

The **Diagnostic (d, R)** menu further contains diagnostics options.

For the detailed illustration of the entire menu structure please refer to the original operating instructions at the end of this chapter.

5.1.6 Changing basic settings

The general basic settings can be changed under menu **Basic Settings Extended Functions (bEF)**. These settings will affect the measurement display and the configuration options in the various main menus. Here you can also change the switching output assignment.

- Press the ▼ key to open the main menu.
- Select menu item (EF) using the ▼ and ▲ keys and open the menu with the ► key.

NOTICE

Disabling normal error handling



Disabling normal error handling and analysis could potentially cause dangerous operating states, dangers to the user or machines. Before using this option, review the hazard potential within the process. With this setting, Bühler Technologies GmbH assumes no liability for injuries to health or material damage caused by this setting.

5.1.6.1 Restore factory settings (Reset)

Use the Reset function (rES) to restore the factory settings. All changes will be lost. Since this will also reset the limits, you must check the liquid level and temperature settings.

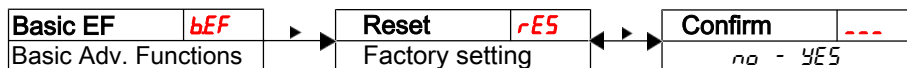

The options are:



Original status:
No,
keep current settings



Original status:
Yes,
reset settings to the factory defaults.

The factory settings are:

Definitions:

<i>SP x / rPx</i>	Switching point / switch-back point x
<i>dS x / drX</i>	Switch-on delay / switch-back delay for switching output x
<i>RxHi / RxLo</i>	Maximum and minimum measurement for output
<i>Rou X</i>	Analogue output signal type
<i>ou X</i>	Switching characteristic for switching output x
<i>Humi / Temp</i>	Humidity / temperature unit
<i>rou X</i>	Switching output x liquid level or temperature monitoring allocation
<i>d, S</i>	Display refresh rate
<i>Loc</i>	Keylock
<i>Suou</i>	Switching output logged
<i>dHm</i>	Delay for recording the minimum / maximum humidity
<i>dTm</i>	Delay for recording the minimum / maximum temperature

Note: For customer-specific specifications the factory preset may vary from those listed here.

Version with 2 switching outputs:

Switching outputs		Basic Settings	
SP1 / rP1	80% / 75%	Errh	YES
dS1 / dr1 / ou1	0 / 0 / Hno	Hun1	-1 - (%)
SP2 / rP2	60 / 55 %	kun1	€
dS2 / dr2 / ou2	0 / 0 / Hno	rou1	Hun1
		rou2	€ERP
		d15	FRSt
		Loc	000

Version with 4 switching outputs:

Switching outputs		Basic Settings	
SP1 / rP1	80% / 75%	Errh	YES
dS1 / dr1 / ou1	0 / 0 / Hno	Hun1	-1 - (%)
SP2 / rP2	60% / 55%	kun1	€
dS2 / dr2 / ou2	0 / 0 / Hno	rou1	Hun1
SP3 / rP3	70 / 65 %	rou2	Hun1
dS3 / dr3 / ou3	0 / 0 / Hno	rou3	€ERP
SP4 / rP4	80 / 75 %	rou4	€ERP
dS4 / dr4 / ou4	0 / 0 / Hno	d15	FRSt
		Loc	000

Version with analogue outputs:

Analogue outputs	
R1H1 / R1Lo / Rou1	0 / 100 / r1
R2H1 / R2Lo / Rou2	0 / 100 / r1

Diagnostic settings:

Diagnostics	
Sdow	out1
dKnn	00
dE.nn	00

5.1.6.2 Disabling normal error handling

Here you can enable/disable normal error handling and analysis.

The function Disable error handling (*Errh*) is used to disable normal error handling and analysis. This may pose dangers to the user or machine.

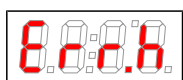
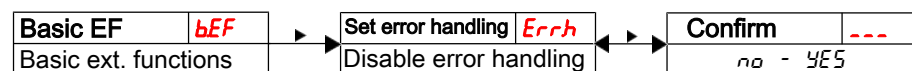

The options are:



Disables normal error handling.

Enables normal error handling (default)

Important note: When exceeding the measuring range or if sensor errors occur, the measurement will be frozen and all six LEDs in the status bar will blink. When the measurement returns to the permissible range the LEDs will stop blinking and the display will refresh again as usual.

5.1.6.3 Set humidity unit

This is where the unit symbol for the humidity is configured:

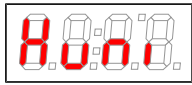
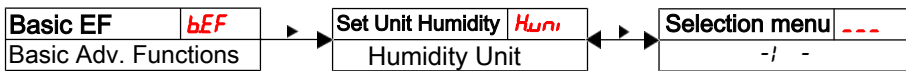

The options are:



Options:
[- 1 -]

Percent

5.1.6.4 Set temperature unit

This is where the unit symbol for the temperature is configured:



The options are:



Degrees
Celsius



Degrees
Fahrenheit

Note:

- Values are automatically converted and the measuring range adjusted. However, always check the respective switching points and switch-back points.

5.1.6.5 Define switching outputs

Here you can define the switching outputs.

Use the “Define switching outputs” function to define the switching outputs (*rou1* and *rou2*). The switching outputs can also be configured as *Err*, *HuMi* or *tEMP*

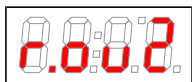
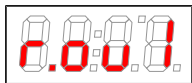
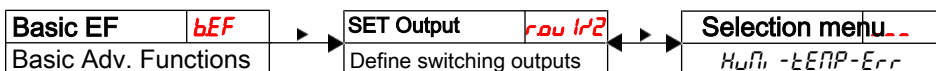

The options are:

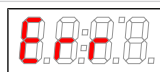

Err



TEMP



HuMi

Options:
[Err, tEMP, HuMi]

Note:

- Switching outputs 1 and 2 can alternatively be wired as error indicators. In this case the output will be connected as a NC contact which opens when exceeding the range or if an error occurs. The LED assigned to this output will generally not be activated, as all 6 LEDs in the status bar will blink if an error occurs.
- When defining a switching output as an error indicator it will no longer be an option for normal switching output settings.

5.1.6.6 Set display refresh rate

The refresh rate of the display can be changed based on the application. The display can also be completely disabled. The LEDs will remain functional.



The options are:



fast



medium



slow



Display off

Note:

- Error messages will still appear, even with the display off.

5.1.6.7 Enable/disable keylock

The keylock can be enabled to prevent unauthorised changes to the device settings.

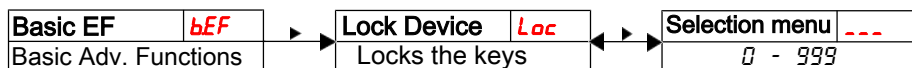

The keylock will be enabled after entering at least one digit > 0. A dot indicates the active digit during this input.



Setting range:
000 to 999



- Use the ► key to open the list of values:
- Enter the digit using the ▼ and ▲ keys (0 to 9) and press the ► key to confirm. The active digit will move one place to the right.
- Lastly, press the ► key to confirm the code. The device will now return to the submenu.

Note:

- To disable the keylock enter: 000

5.1.7 Switching outputs

All switching outputs are configured the same way. The switching output number is therefore represented by x. Open the switching output to be configured from the menu for the respective measured variable.

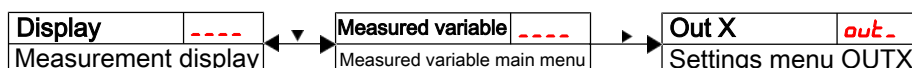

The switching output allocation and other basic settings related to all switching outputs can be configured in menu **Basic Settings Advanced Functions**.

Use submenu **Advanced Functions** to configure additional settings for each individual switching output which e.g. affect the switching characteristics of the output. The output can also be tested here.

5.1.7.1 Switching output x: Definition of the switching characteristic

The switching characteristic for the output can be configured under the following menu:



The options are:

Hysteresis Function

NO contact or NC contact function when the output signal is set when exceeding the configured switching point. The output signal will be deleted if the value is below the configured switch-back point.



Hysteresis function as the NO contact

Here, NO contact (H_{no}) means the PNP switching output is closed above switching point SP_x and opens below switching point rP_x .



Hysteresis function as the NC contact

Here, NC contact (H_{nc}) means the PNP switching output is open above switching point SP_x and closes below switching point rP_x .

Also see the explanation in the drawing below.

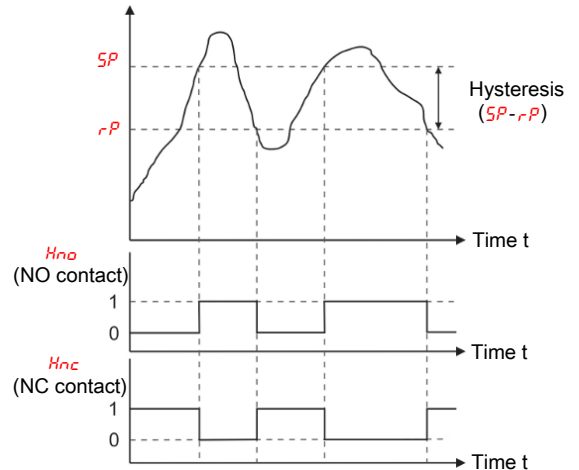

Window function

NO contact or NC contact function defining a signal window. When the measuring window is reached the output signal is set and deleted upon exiting.



Window function as NO contact

Here, NO contact (F_{no}) means the PNP switching output is closed if the value is within the window. Otherwise the switching output will be open.



Window function as NC contact

Here, NC contact (F_{nc}) means the PNP switching output is open if the value is within the window. Otherwise the switching output will be closed.

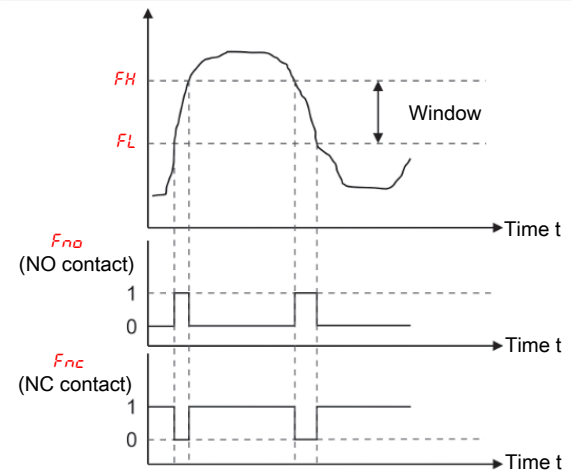

Frequency output

If the output is defined as a frequency output, a square wave signal with a frequency between 1 Hz and 100 Hz proportional to the measurement will be output.



Frequency output

Note: To increase the slew rate of the square wave signal, we recommend loading the switching output with an load of 10 k Ω .

Example: $F_{Lo} = 15^\circ C$, $F_{Hi} = 80^\circ C$
with temperature T and frequency f :

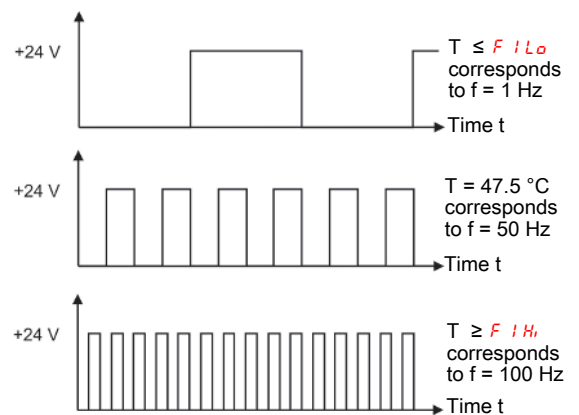

Note: The designation of the switching function may vary:

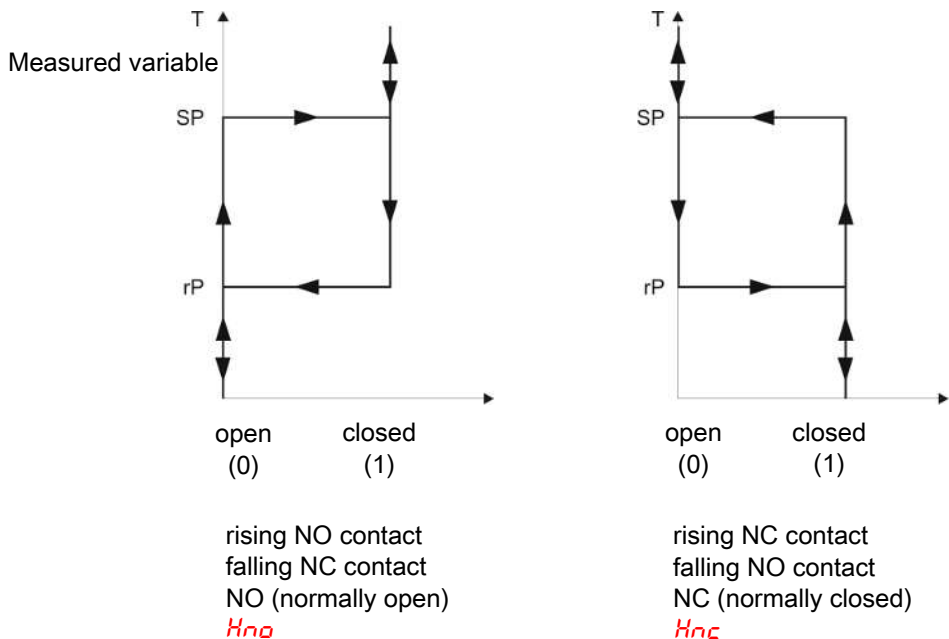

5.1.7.2 Switching output x: Upper switching limit (switching point)

The upper switching limit for switching output Out x can be defined with the following submenu:

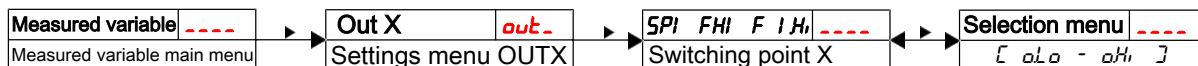

Switching point for OUT x

Note:

- The switching point must be set to within the range limits (see menu **Basic Settings Advanced Functions**).
- If switching output OUT x was assigned the function **Window**, will appear. The setting corresponds with the upper window limit.
- If switching output OUT x was assigned the function **Frequency output**, will appear. The setting corresponds to the frequency 100 Hz.

5.1.7.3 Switching output x: Lower switching limit (switch-back point)

The lower switching limit for switching output Out x can be defined with the following submenu:

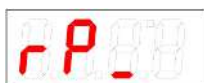
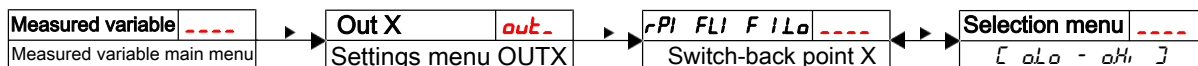

Switch-back point for OUT x

Note:

- The switch-back point must be set to within the range limits.
- If switching output OUT x was assigned the function **Window**, will appear. The setting corresponds with the lower window limit.
- If switching output OUT x was assigned the function **Frequency output**, will appear. The setting corresponds to the frequency 1 Hz.

5.1.7.4 Switching output x: Switch-on delay

The menu **Advanced Functions** *EFx* is used to configure additional settings for switching output x. The submenu is at the second submenu level.

The switching and switch-back delay prevents the alarm being triggered too frequently in unstable conditions. The switching delay can be configured with the following menu:

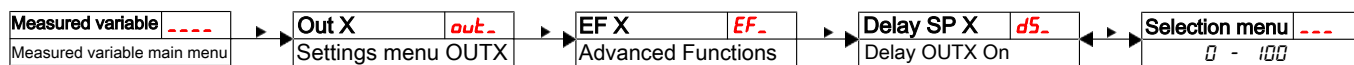

Time span in seconds during which the signal must be continuously present for the switching output to respond.

Note:

- If switching output OUT x was assigned the function **Window**, the setting corresponds to the switch-on delay which detects valid reaching of the measuring window.
- If switching output OUT x was assigned the function **Frequency output**, this value will have no affect.

Setting range:
0...100 seconds

5.1.7.5 Switching output x: Switch-back delay

The switch-back delay can be configured with the following menu:

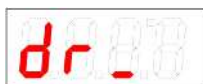
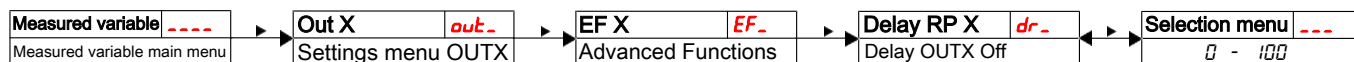

Switch-back signal delay for OUT x.

Time span in seconds during which the signal must be continuously present for the switching output to respond.

Note:

- If switching output OUT x was assigned the function **Window**, the setting corresponds to the switch-on delay which detects valid closing of the measuring window.
- If switching output OUT x was assigned the function **Frequency output**, this value will have no affect.

Setting range:
0...100 seconds

5.1.7.6 Switching output x: Testing the switching output

The switching output test can be started with the following menu:

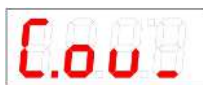
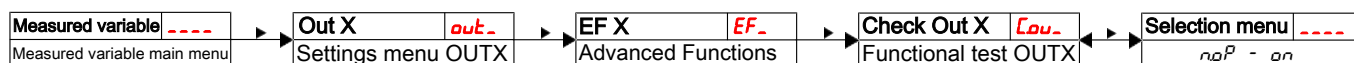

Switching output test option

Options when setting *ou 1* to *Hno* / *Hnc* / *Fno* / *Fnc*:



Normal switching output operation

Switching output permanently off disabled

Switching output permanently activated

Options when setting *ou 1* to *F? :*



Normal mode as frequency output

Output Frequency 1 Hz

Output Frequency 100 Hz



Note:

- **After completing the test, set the function to normal mode *noP*.**

5.1.7.7 Change status LED display function

The LEDs in the display indicate the switching status of the output. The following table shows how LEDs are allocated to the switching output:

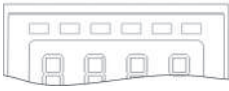
Numbering LED	Switching output x	Allocation for 2 switching outputs	Allocation for 4 switching outputs
LED 1 2 3 4 5 6 	1	Reserved for IO-Link	LED 1 - yellow
	2	LED 2 - red	LED 2 - red
	3	Reserved	LED 3 - yellow
	4	Reserved	LED 4 - red
	5	Reserved	
	6	Reserved	

In the factory setting the LED indicates the physical status of the PNP switching output (switching output closed – LED on).

The logical indicator function may need to be different from the physical signal on the switching output. You can therefore also reverse this indication with this menu (switching output open – LED on).

Example:





You have 2 switching outputs for the temperature, configured as:

- **Switching output 1:** Max contact, rising NO contact. The LED lights up when exceeding the maximum temperature and the temperature is higher than the desired range. So this LED lighting up indicates an “Error” status.
- **Switching output 2:** Min contact, rising NO contact. So in the factory setting, the LED lights up when exceeding the minimum temperature. So in this case the LED would light up if the status is okay.

The table shows an example with the factory setting and with inverted status function for LED3. The switching points are defined as:

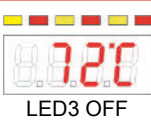
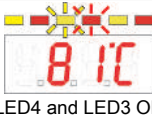
SP3 = 70 °C, rP3 = 65 °C

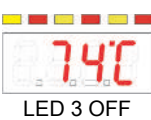
SP4 = 80 °C, rP4 = 75 °C

	Factory setting	Status function LED 3 inverted	State	Status
A	 LED3 ON	 LED3 OFF	Temperature rises to > 70 °C PNP switching output 3 closed	OK
B	 LED4 and LED3 ON	 only LED4 ON	Temperature rises to > 80 °C PNP switching output 4 closed	Error
C	 LED3 ON	 LED 3 OFF	Temperature falls to < 75 °C PNP switching output 4 open	OK
D	 LED3 OFF	 LED3 ON	Temperature falls to < 65 °C PNP switching output 3 open	Error

Here you can reverse the LED status function for a contact: the LED lights up if the contact is open, so below the minimum temperature, and the LED lighting up again indicates an “Error” status.

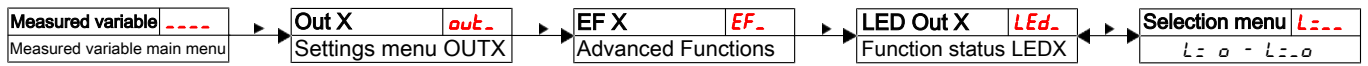

The options are:



LED = output;
the LED lights up when the PNP switching output is closed.

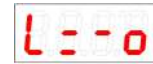

LED = -output;
the LED lights up when the PNP switching output is open.

NOTICE



The display function of the status LED affects event logging! Please note chapter “Diagnostic options”.

5.1.8 Analogue outputs

5.1.8.1 Models with analogue output

In the factory setting the analogue output signal rises as the humidity increases. The range adjustment and the signal type can be set in the menu.

5.1.8.2 Analogue output x: Assigning the upper limit

Humidity

Used to configure at which humidity level to output the maximum analogue signal. This is configured in menu:

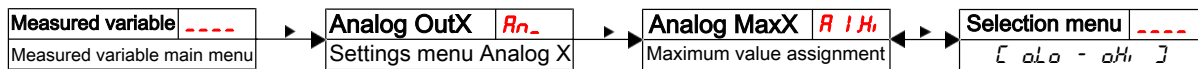

Note:

- The output range setting must not be less than 10 % of the measuring range: $A.H. - A.L. >= 10\% * (0 - 100)$
- If the range is set too low, the analogue value output may have grades.

Setting range:
0 % to 100 %

Temperature

Used to configure at which temperature to output the maximum analogue signal. This is configured in menu:

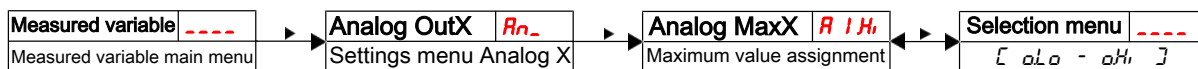

Note:

- The output range setting must not be less than 10 % of the measuring range: $A.H. - A.L. >= 10\%$
- If the range is set too low, the analogue value output may have grades.

Setting range:
-20 °C to 120 °C
(-4 °F to 248 °F)

5.1.8.3 Analogue output x: Lower limit assignment

Humidity

Used to configure at which humidity level to output the minimum analogue signal. This is configured in menu:

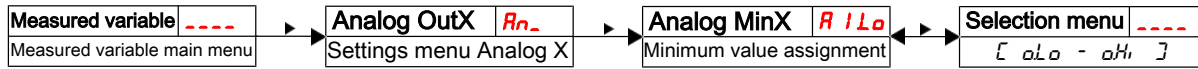

Note:

- The output range setting must not be less than 10 % of the measuring range: $A.Hi - A.Lo >= 10\% * (0 - 100)$
- If the range is set too low, the analogue value output may have grades.

Setting range:
0 % to 100 %

Temperature

Used to configure at which temperature to output the minimum analogue signal. This is configured in menu:

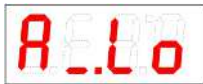
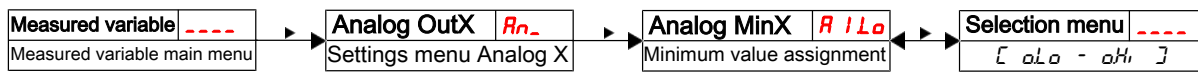

Note:

- The output range setting must not be less than 10 % of the measuring range: $A.Hi - A.Lo >= 10\%$
- If the range is set too low, the analogue value output may have grades.

Setting range:
-20 °C to 120 °C
(-4 °F to 248 °F)

5.1.8.4 Analogue output x: Signal type assignment

The analogue output can be defined as a voltage or current output with different value ranges. This is configured in menu:

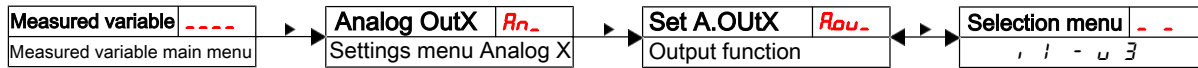

The options are:



4 mA to 20 mA



2 V to 10 V



0 V to 10 V



0 V to 5 V

5.1.8.5 Analogue output x: Testing the analogue output

The analogue output can be tested. The highest, mean and lowest analogue value can be output successively. This is configured in menu:

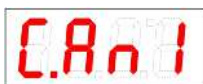
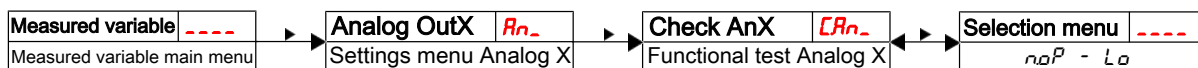

The options are:



Normal mode



Highest analogue value output



Mean analogue value output



Lowest analogue value output



Note:

- After completing the test, set the function to normal mode **noP**.

5.1.9 Diagnostic options

The device is able to log events for a switching output. The LED lighting up is considered an event. The logging of switching procedures therefore depends on how the LED switching function is configured.

The configuration and analysis can be carried out here.

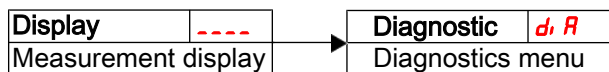

NOTICE



Only one switching output can be logged. The switching output to be logged is configured in menu item **Set Journal Out** (*Journal*).

- Press the ▼ key to open the main menu.
- Select menu item *d, R* with the ▼ and ▲ keys.

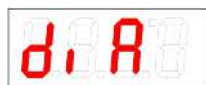

From here you will be able to access various diagnostic values and measurement monitoring logs.

- Open the menu with the ► key.
You can now change or view the diagnostic settings.

5.1.9.1 View logbook

The last 6 events for the switching output being logged can be viewed here and all entries deleted:

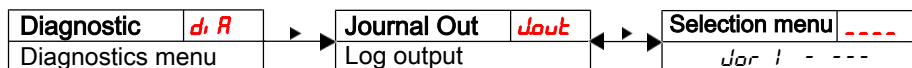

The journal entries will be displayed as:

- Most recent event *Journal 1* occurred x hours (h) / days (d) ago,
- Events 2 to 5 occurred x hours / days ago,
- The oldest event *Journal 6* occurred x hours / days ago,
- Delete function (---)

Example:

Journal 1 ⇔ 13h, key ▼
Journal 2 ⇔ 24h, key ▼, ▲
Journal 3 ⇔ 6.1h, key ▼, ▲
Journal 4 ⇔ 82h, key ▼, ▲
Journal 5 ⇔ non 8, key ▼, ▲
Journal 6 ⇔ non 8, key ▼, ▲
 ---, key ▲; ► = delete

* not yet populated, only 4 events have occurred



The information displayed will alternate between the index and time for entry x, e.g. *Journal 1* ⇔ 14h for the most recent event 1.4 hours ago.

Press the ► key to return to the submenu or use ▼, ▲ to select the next journal entry.

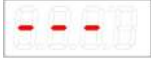
Confirming the information  with the ► key will delete the list of events and return to the submenu.

Note:

- If no events have been logged, the display will alternate between *Journal X* and *non*.

5.1.9.2 View error logbook

Here you can open and delete error messages:



To delete the error messages:

- Display error number
- Delete function

Example:

d, button ▼
 ---, button ▲; ► = delete



If an error occurs, this shows the error number (see table in chapter [Troubleshooting](#) [> page 27]).

Press the ► key to return to the submenu or use ▼, to display.

Confirming the display with the ► key will clear the error messages.

5.1.9.3 Maximum and minimum humidity

Used to view or delete the maximum and minimum humidity:



The journal entries will be displayed as:

- Maximum humidity,
- occurred x hours / days ago,
- Minimum humidity,
- occurred x hours / days ago,
- Delete function

Example:

150, key ▼
84h, key ▼, ▲
60, key ▼, ▲
2.1h, key ▼, ▲
 ---, key ▲; ► = delete



Press the ► key to return to the submenu or use ▼, ▲ to select the next Journal entry.

Confirming the information with the ► key will delete the list of events and return to the submenu.

Menu order:
 Max. value,
 time
 min. value
 time
 delete

5.1.9.4 Maximum and minimum temperature

Used to view or delete the saved maximum and minimum temperature:

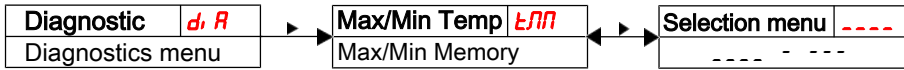

The journal entries will be displayed as:

- Maximum temperature,
- occurred x hours / days ago,
- Minimum temperature,
- occurred x hours / days ago,
- Delete function

Example:

72 °C, key ▼
 84h, key ▼, ▲
 22 °C, key ▼, ▲
 2.1h, key ▼, ▲
 ---, key ▲; ► = delete



Press the ► key to return to the submenu or use ▼, ▲ to select the next Journal entry.

Confirming the information  with the ► key will delete the list of events and return to the submenu.

Menu order:
 Max. value,
 time
 min. value
 time
 delete (reset)

5.1.9.5 Define switching output to log

Used to select the switching output to be logged. Only one switching output can be logged.

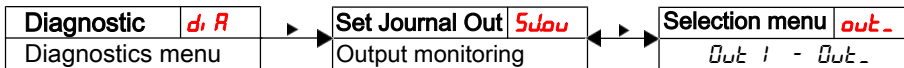

Switching output logging.

Options:
 out. 1 to out.X

NOTICE



Values are backed up from volatile to non-volatile memory approx. every three hours.

5.1.9.6 Delay for storing the Min/Max Humidity

A delay time for saving the minimum and maximum humidity can be set to record reliable values when input values fluctuate. Here, enter the time span in seconds during which the signal must be continuously present before the humidity is logged.

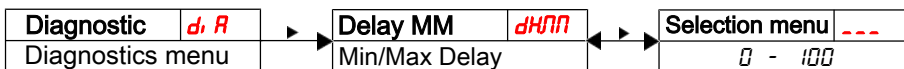

- Use the ► key to open the list of values.
- Set the value with the ▼ and ▲ keys and press ► to confirm (e.g. 5 (seconds)). The unit will return to the submenu.

Setting range:
 0...100 seconds

5.1.9.7 Delay for storing the Min/Max Temperature

A delay time for saving the minimum and maximum temperature can be set to record reliable values when temperatures fluctuate. Here, enter the time span in seconds during which the signal must be continuously present before the temperature is logged.

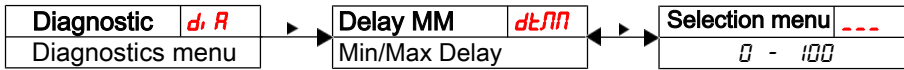

- Use the ► key to open the list of values.
- Set the value with the ▼ and ▲ keys and use the ► key to confirm (e.g. 5 (seconds)). The device will return to the submenu.

Setting range:
0...100 seconds

5.2 BCM-WS

This explanation of the operation applies to the sensor versions without display.

5.2.1 Start-up procedure

The device will automatically switch on when connected to power.

With IO-Link, the sensor will be in SIO mode if there is no master. In SIO mode the sensor will work the same as a normal PNP switching output.

5.2.2 Parameter configuration

The IO-Link interface can be used to configure the parameters as switching point, switch-back point or temperature unit.

5.2.3 Factory setting

(can only be restored via IO-Link)

Switching outputs		Basic Settings	
Switching point/switch-back point	80% / 75%	Error message	Inactive
Delay switching point/switch-back point	0 / 0	Temperature unit	°C
Characteristic	Hysteresis as NC contact (Hnc)	Switching output assignment	Humidity

5.2.4 Switching outputs

The sensor has one switching output assigned to humidity. The threshold is preset to 80 %. The switching function is a NC contact. This switching output can be configured ex works or via the digital interface.

For the functionality please refer to chapter [Switching outputs](#) [> page 15].

5.2.5 Analogue outputs

The sensor version features up to two 4-20 mA analogue outputs. The analogue outputs are available for the relative humidity and temperature. The scale is preset and can be factory configured or via the digital interface. By default the analogue output shows the relative humidity as 0 % to 100 %. The analogue output shows the temperature from -20 °C to 120 °C.

6 Cleaning and Maintenance

Regularly check sealing screw connections for leaks, particularly if vibration may occur. Apart from this the device is maintenance-free.

The method for cleaning the devices must be adapted to the IP protection class of the devices. Do not use cleaners which could damage the device materials. Isopropyl alcohol is recommended for cleaning the sensor element. The parts of the sensor in contact with the medium should be swirled in a container with the specified cleaning agent and then dried in ambient air. Never clean the sensor with compressed air or a jet of fluid to prevent damaging the sensor elements.

7 Service and repair

This chapter contains information on troubleshooting and correction should an error occur during operation.

Repairs to the unit must be performed by Bühler authorised personnel.

Please contact our Service Department with any questions:

Tel.: +49-(0)2102-498955 or your agent

If the equipment is not functioning properly after correcting any malfunctions and switching on the power, it must be inspected by the manufacturer. Please send the equipment inside suitable packaging to:

Bühler Technologies GmbH

- Reparatur/Service -

Harkortstraße 29

40880 Ratingen

Germany

Please also attach the completed and signed RMA decontamination statement to the packaging. We will otherwise be unable to process your repair order.

You will find the form in the appendix of these instructions, or simply request it by e-mail:

service@buehler-technologies.com.

7.1 Removal information









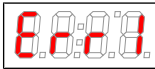

The housing temperature depends on the process temperature, therefore remember when working on the device:

Allow the device to cool down before performing maintenance or repairs.

Before remove the device, ensure the system is depressurised to prevent liquid from escaping. If necessary, use a collection container.

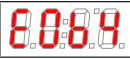
Please observe the safety notices in chapter [Setup and connection](#) [> page 7].

7.2 Troubleshooting

Problem/malfunction	Possible cause	Action
No display	– No supply voltage	– Check cable and replace, if necessary
Error messages on the display:		
Alternating between Err and Exxx: e.g.  ↔ 		
 Error 001	– Ambient temperature too low	– Maintain limits
 Error 002	– Ambient temperature too high	– Maintain limits
 Error 004	– Pt100 failure (short-circuit)	– Send device in for repair
 Error 008	– Pt100 failure (cable break)	– Send device in for repair
 Error 032	– Sensor failure (supply line open)	– Send device in for repair
 Error 064	– Transmitter (moisture)	– Input signal too low
 Error 128	– Transmitter (moisture)	– Input signal too high
 Error 256	– Transmitter (temperature)	– Input signal too low
 Error 512	– Transmitter (temperature)	– Input signal too high
 Error 1024	– Internal error	– Please contact customer service

Possible errors

Problem / Malfunction	Possible cause	Action
Switching output not triggering when exceeding limits	– Switching output configured incorrectly	– In submenu LOUX : “Test Switching Output” to ensure normal mode
	– Switching output defect	– In submenu LOUX : “Test Switching Output” to test the desired switching output
Switching output constantly switching	– Switching output configured incorrectly	– In submenu LOUX : “Test Switching Output” to ensure normal mode
	– Switching output defect	– In submenu LOUX : “Test Switching Output” to test the desired switching output
The analogue doesn’t receive the full/correct output current	– Wrong signal type set	– In submenu POUX : Check and if necessary set the correct signal type (current/voltage output)
	– Load too high (current output)	– Reduce load to permissible value
Analogue output doesn’t change the output signal when the input signal changes	– Analogue output configured incorrectly	– In submenu LOUX : „Test Analogue Output“ to ensure normal mode

7.3 Spare parts and accessories

Accessories

Item no. 4-pin	Item no. 8-pin	Description
9144 05 0010	9144 05 0048	Connecting cable M12x1, 1.5 m, angular coupling and straight plug
9144 05 0046	9144 05 0049	Connecting cable M12x1, 3.0 m, angular coupling and straight plug
9144 05 0047	9144 05 0033	Connecting cable M12x1, 5.0 m, angular coupling and strands

8 Disposal

Dispose of parts so as not to endanger the health or environment. Follow the laws in the country of use for disposing of electronic components and devices during disposal.

9 Appendices

9.1 Technical Data BCM-WS

Sensor versions	BCM-WS100	BCM-WS120	BCM-WS160
Max. operating pressure	50 bar	50 bar	1 bar
Medium	-20 °C to +80 °C *	-20 °C to +80 °C *	-20 °C to +80 °C *
Threaded connection	G3/4" pipe thread, EOlastic seal	G1/2" pipe thread, EOlastic seal	Flange (DIN 24557/T2), seal FKM
max. torque	20 Nm	20 Nm	---
Sensor length from seal face	36 mm	34 mm	min. 100 mm to max. 1200 mm
max. flow rate	110 L/min	110 L/min	110 L/min
max. flow rate at sensor	5 m/s	5 m/s	5 m/s
Chemical resistance	Mineral oil based liquids, synthetic esters and biopetroleums	Mineral oil based liquids, synthetic esters and biopetroleums	Mineral oil based liquids, synthetic esters and biopetroleums
Ambient temperature	-20 °C to + 70 °C	-20 °C to + 70 °C	-20 °C to + 70 °C
Supply voltage (U _B)	18 - 30 V (nominal voltage 24 VDC) 12 V on request for version 1S2A Note load	18 - 30 V (nominal voltage 24 VDC) 12 V on request for version 1S2A Note load	18 - 30 V (nominal voltage 24 VDC) 12 V on request for version 1S2A Note load

*Medium temperature up to 120 °C, from 90 °C no accurate measurand output possible within the tolerances.

Material/Version	BCM-WS100	BCM-WS120	BCM-WS160
Housing	Stainless steel/aluminium	Stainless steel/aluminium	Stainless steel/aluminium
Material in contact with media	1.4301, 1.4571, 2.4478, FR4, glass	1.4301, 1.4571, 2.4478, FR4, glass	1.4301, 1.4571, 2.4478, FR4, glass
Weight	approx. 205 g	approx. 170 g	approx. 930 g at L = 200 / + 50 g per 100 mm
IP rating	IP67*	IP67*	IP67*

*with plug-in connector screwed on

IO-Link

IO-Link	Revision 1.1
Baudrate	COM2 (38.4 k)
SIO Mode	Yes
min. time period	20 ms

Moisture measurement

Measuring range	0 - 100 % rel. humidity
Accuracy	± 3 % FS
Analog output	4 – 20 mA (0 – 100 % relative humidity)
Tolerance	± 0.5 % FS
Load Ω	= (U _B – 8 V) / 0.02 A

Switching output for humidity

PNP switching output ¹⁾²⁾	Fixed to 80 % relative humidity NC (normally closed)
Switching current	max. 0.2 A

¹⁾ others on request

²⁾ adjustable via IO-Link

Temperature measurement

Measuring range	-20 °C to +120 °C
Accuracy	± 1.5 % FS
Analog output	4 – 20 mA (-20 to +120 °C)
Tolerance	± 0.5 % FS
Load Ω	= $(U_b - 8V) / 0.02 A$

9.2 Technical Data BCM-WR/BCM-WD

Sensor with Display and Control Unit

General Technical Data

Max. operating pressure	50 bar 1 bar
Medium	-20 °C to + 80 °C *
Threaded connection	G3/4" pipe thread, EOlastic seal
max. torque	20 Nm
Sensor length from seal face	36 mm
max. flow rate	110 L/min
max. flow rate at sensor	5 m/s
Chemical resistance	Mineral oil based liquids, synthetic esters and biopetroleums

*Medium temperature up to 120 °C, from 90 °C no accurate measurand output possible within the tolerances.

Analysis and Display Electronics

Display	4 character 7 segment LED
Display unit	0 – 100 % relative humidity
Operation	via 3 keys
Memory	Min./Max. data memory
Starting current input	approx. 100 mA for 100 ms
Current input during operation	approx. 50 mA (without current- and switching outputs)
Supply voltage (U _B)	18 – 30 VDC (nominal voltage 24 VDC)
Ambient temperature	-20 °C to +70°C
Display resolution	0.5 %, 0.5 °C, °F

Version BCM-WR remote display with sensor

Mounting	35 mm top hat rail mounting/ G3/4
Weight	approx. 335 g incl. sensor
Display housing	PA
IP rating	IP65* (display)/IP67* (sensor)

Dimensions

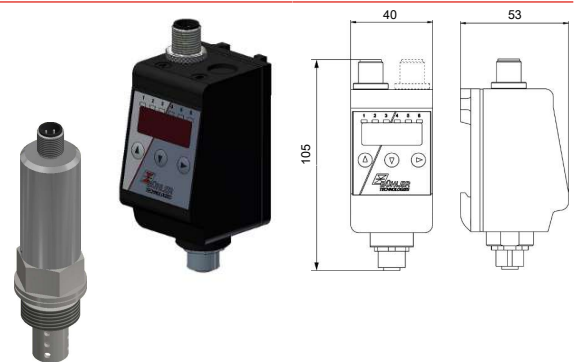

* with plug-in connector screwed on

Version BCM-WD with attached sensor

Mounting	G3/4 / G1/2
Weight	approx. 270 g
Display housing	PA
IP rating	IP65* (display)

Dimensions

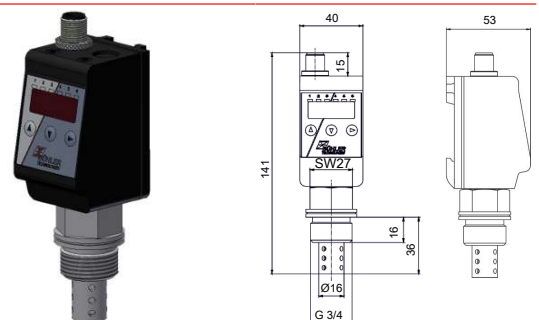

*with plug-in connector screwed on

IO-Link

IO-Link	Revision 1.1
Baudrate	COM3 (230.4 k)
SIO Mode	Yes
min. time period	10 ms

Moisture measurement

Measuring range	0 - 100 % rel. humidity
Accuracy	± 3 % FS
Analog output	Parametrisable current or voltage output (4 - 20 mA, 2 - 10 V, 0 - 10 V or 0 - 5 V)
Tolerance	± 0.5 % FS
Load Ω (current output)	= (U _B - 8 V) / 0.02 A

Switching outputs

PNP switching output	Parametrisable switching function and switching output
Switching current	max. 0.2 A per output

Temperature measurement

Measuring range	-20 °C to +120 °C
Accuracy	± 1.5 % FS
Analog output	Parametrisable current or voltage output (4 - 20 mA, 2 - 10 V, 0 - 10 V or 0 - 5 V)
Tolerance	± 0.5 % FS
Load Ω (current output)	= (U _B - 8 V) / 0.02 A

9.3 Dimensions BCM-WS

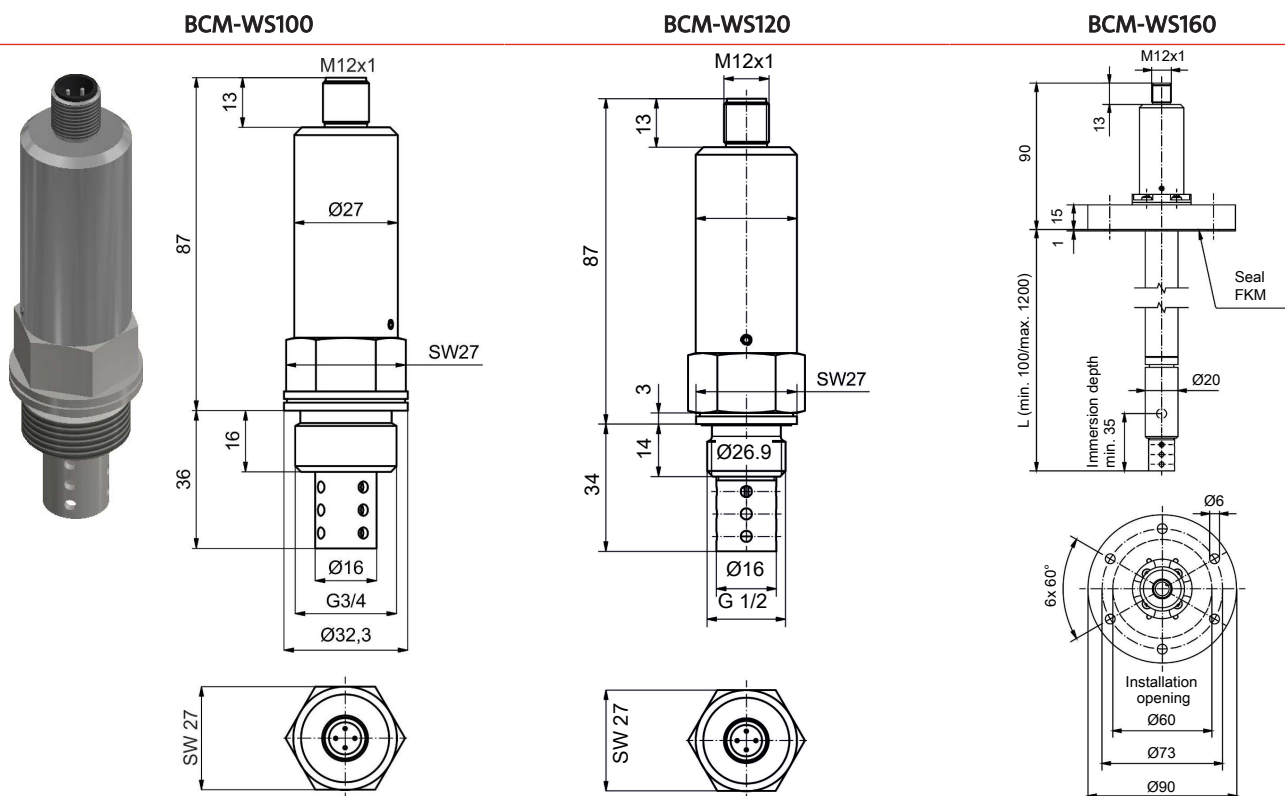

9.4 Outputs BCM-WS

Version	1S2A	1D
Plug (base)	1 x M12 – 8-pin	1 x M12 – 4-pin
Switching output (fixed)	X	
IO-Link		X
Humidity analogue output	X	
Temperature analogue output	X	

9.5 Outputs BCM-WD/BCM-WR

Version	2S2A	1D1S	4S2A
Plug (base)	1 x M12 – 8-pin	1 x M12 – 4-pin	1 x M12 – 4-pin
Display & remote			1 x M12 – 8-pin
Sensor connection jack (bottom)	1 x M12 – 8-pin	1 x M12 – 8-pin	1 x M12 – 8-pin
Remote			
Switching outputs	2 x	1 x	4 x
IO-Link		X	
Humidity analog output	X		X
Temperature analog output	X		X

9.6 Pin assignment BCM-WS

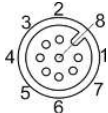
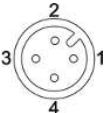
	WS-1S2A	WS-1D
		
Panel plug/jack	8-pin	4-pin
	Standard	IO Link
Pin		
1	L+	L+
2	L-	
3	S1 humidity	L-
4		C/Q
5		
6	I1 humidity	
7	I2 temp.	
8		

9.7 Pin assignment BCM-WR/WD

	Plug A			Plug B	Sensor connection jack
	WD/WR-2S2A 	WD/WR-1D1S 	WD/WR-4S2A 	WD/WR-4S2A 	WR
Panel plug/jack	8-pin Standard	4-pin IO-Link	4-pin IO-Link	8-pin	8-pin
Pin					
1	L+	L+	L+		L+
2	L-	DO/S2	S2		L-
3	S1 Humidity	L-	L-	S3	
4		C/Q	S1		
5	S2-Temp.			S4	
6	I1 humidity			I1 humidity	I1 humidity
7	I2 temp.			I2 temp.	I2 temp.
8					

9.8 Display ranges

Name	Menu/Unit	Display	Range from/ with unit	Range to/ with unit
Temperature				
°C	<i>°C</i>	<i>°C</i>	-100 °C	999 °C
°F	<i>°F</i>	<i>°F</i>	-100 °F	999 °F
Humidity				
Percent	<i>%</i>	-	-100 %	999 %

9.9 Current settings

Switching outputs	Basic Settings	Diagnostics
<i>SP1 / rP1</i>	<i>Errh</i>	<i>Suou</i>
<i>dS1 / dr1 / ou1</i>	<i>Humi</i>	<i>dhfll</i>
<i>SP2 / rP2</i>	<i>Errh</i>	<i>dhfll</i>
<i>dS2 / dr2 / ou2</i>	<i>rou1</i>	
<i>SP3 / rP3</i>	<i>rou2</i>	
<i>dS3 / dr3 / ou3</i>	<i>rou3</i>	
<i>SP4 / rP4</i>	<i>rou4</i>	
<i>dS4 / dr4 / ou4</i>	<i>di5</i>	
Analogue outputs	<i>Loc</i>	
<i>R1Hi / R1Lo / Rou1</i>		
<i>R2Hi / R2Lo / Rou2</i>		

Date: _____

Signature: _____

9.10 Menu Sequence Overview

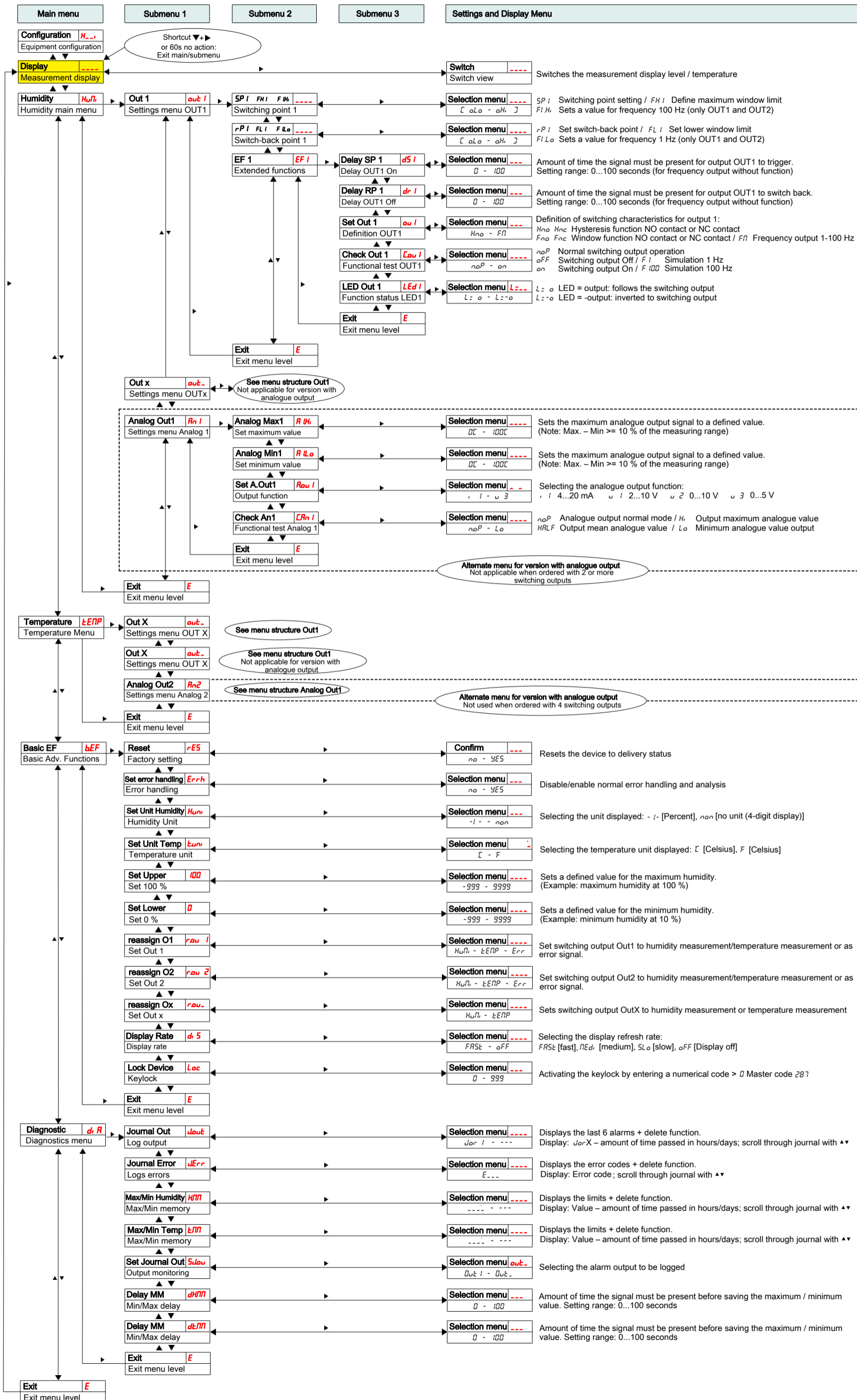

10 Attached documents

- Declaration of conformity KX150001
- RMA - Decontamination Statement

EU-Konformitätserklärung
EU-declaration of conformity



Hiermit erklärt Bühler Technologies GmbH,
dass die nachfolgenden Produkte den
wesentlichen Anforderungen der Richtlinie

*Herewith declares Bühler Technologies GmbH
that the following products correspond to the
essential requirements of Directive*

2014/30/EU

(Elektromagnetische Verträglichkeit / *electromagnetic compatibility*)

in ihrer aktuellen Fassung entsprechen.

in its actual version.

Produkt / products: Ölfeuchtesensor / Oil moisture sensor
Typ / type: BCM-WR, BCM-WD, BCM-WS

Das Betriebsmittel dient zur Überwachung des Wasseranteiles in Öl und zur Temperaturmessung.
The equipment is intended for monitoring the water content of oil and the temperature.

Das oben beschriebene Produkt der Erklärung erfüllt die einschlägigen
Harmonisierungsrechtsvorschriften der Union:

*The object of the declaration described above is in conformity with the relevant Union harmonisation
legislation:*

EN 61326-1:2013

Zusätzlich wurden die wesentlichen Gesundheits- und Sicherheitsanforderungen aus der
Niederspannungsrichtlinie (2014/35/EU) und der EN ISO 12100:2010 berücksichtigt.
*In addition, the essential health and safety requirements of the Low Voltage Directive (2014/35/EU)
and EN ISO 12100:2010 have been used.*

Die alleinige Verantwortung für die Ausstellung dieser Konformitätserklärung trägt der Hersteller.
This declaration of conformity is issued under the sole responsibility of the manufacturer.

Dokumentationsverantwortlicher für diese Konformitätserklärung ist Herr Stefan Eschweiler mit
Anschrift am Firmensitz.

*The person authorised to compile the technical file is Mr. Stefan Eschweiler located at the company's
address.*

Ratingen, den 26.11.2018

Stefan Eschweiler
Geschäftsführer – *Managing Director*

Frank Pospiech
Geschäftsführer – *Managing Director*

RMA-Formular und Erklärung über Dekontaminierung

RMA-Form and explanation for decontamination



RMA-Nr./ RMA-No.

Die RMA-Nummer bekommen Sie von Ihrem Ansprechpartner im Vertrieb oder Service./ You may obtain the RMA number from your sales or service representative.

Zu diesem Rücksendeschein gehört eine Dekontaminierungserklärung. Die gesetzlichen Vorschriften schreiben vor, dass Sie uns diese Dekontaminierungserklärung ausgefüllt und unterschrieben zurücksenden müssen. Bitte füllen Sie auch diese im Sinne der Gesundheit unserer Mitarbeiter vollständig aus./ This return form includes a decontamination statement. The law requires you to submit this completed and signed decontamination statement to us. Please complete the entire form, also in the interest of our employee health.

Firma/ Company

Firma/ Company
Straße/ Street
PLZ, Ort/ Zip, City
Land/ Country

Ansprechpartner/ Person in charge

Name/ Name
Abt./ Dept.
Tel./ Phone
E-Mail
Serien-Nr./ Serial No.
Artikel-Nr./ Item No.

Gerät/ Device
Anzahl/ Quantity
Auftragsnr./ Order No.

Grund der Rücksendung/ Reason for return

- Kalibrierung/ Calibration Modifikation/ Modification
 Reklamation/ Claim Reparatur/ Repair
 andere/ other

bitte spezifizieren/ please specify

Ist das Gerät möglicherweise kontaminiert?/ Could the equipment be contaminated?

- Nein, da das Gerät nicht mit gesundheitsgefährdenden Stoffen betrieben wurde./ No, because the device was not operated with hazardous substances.
 Nein, da das Gerät ordnungsgemäß gereinigt und dekontaminiert wurde./ No, because the device has been properly cleaned and decontaminated.
 Ja, kontaminiert mit:/ Yes, contaminated with:



explosiv/
explosive



entzündlich/
flammable



brandfördernd/
oxidizing



komprimierte
Gase/
compressed
gases



ätzend/
caustic



giftig,
Lebensgefahr/
poisonous, risk
of death



gesundheitsge-
fährdend/
harmful to
health



gesund-
heitsgefährlich/
health hazard



umweltge-
fährdend/
environmental
hazard

Bitte Sicherheitsdatenblatt beilegen! / Please enclose safety data sheet!

Das Gerät wurde gespült mit:/ The equipment was purged with:

Diese Erklärung wurde korrekt und vollständig ausgefüllt und von einer dazu befugten Person unterschrieben. Der Versand der (dekontaminierten) Geräte und Komponenten erfolgt gemäß den gesetzlichen Bestimmungen.

This declaration has been filled out correctly and completely, and signed by an authorized person. The dispatch of the (decontaminated) devices and components takes place according to the legal regulations.

Falls die Ware nicht gereinigt, also kontaminiert bei uns eintrifft, muss die Firma Bühler sich vorbehalten, diese durch einen externen Dienstleister reinigen zu lassen und Ihnen dies in Rechnung zu stellen.

Should the goods not arrive clean, but contaminated, Bühler reserves the right, to commission an external service provider to clean the goods and invoice it to your account.

Firmenstempel/ Company Sign

Datum/ Date

rechtsverbindliche Unterschrift/ Legally binding signature



Die Analyse defekter Baugruppen ist ein wesentlicher Bestandteil der Qualitätssicherung der Firma Bühler Technologies.

Um eine aussagekräftige Analyse zu gewährleisten muss die Ware möglichst unverändert untersucht werden. Es dürfen keine Veränderungen oder weitere Beschädigungen auftreten, die Ursachen verdecken oder eine Analyse unmöglich machen.

Bei elektronischen Baugruppen kann es sich um elektrostatisch sensible Baugruppen handeln. Es ist darauf zu achten, diese Baugruppen ESD-gerecht zu behandeln. Nach Möglichkeit sollten die Baugruppen an einem ESD-gerechten Arbeitsplatz getauscht werden. Ist dies nicht möglich sollten ESD-gerechte Maßnahmen beim Austausch getroffen werden. Der Transport darf nur in ESD-gerechten Behältnissen durchgeführt werden. Die Verpackung der Baugruppen muss ESD-konform sein. Verwenden Sie nach Möglichkeit die Verpackung des Ersatzteils oder wählen Sie selber eine ESD-gerechte Verpackung.

Beachten Sie beim Einbau des Ersatzteils die gleichen Vorgaben wie oben beschrieben. Achten Sie auf die ordnungsgemäße Montage des Bauteils und aller Komponenten. Versetzen Sie vor der Inbetriebnahme die Verkabelung wieder in den ursprünglichen Zustand. Fragen Sie im Zweifel beim Hersteller nach weiteren Informationen.

Analysing defective assemblies is an essential part of quality assurance at Bühler Technologies.

To ensure conclusive analysis the goods must be inspected unaltered, if possible. Modifications or other damages which may hide the cause or render it impossible to analyse are prohibited.

Electronic assemblies may be sensitive to static electricity. Be sure to handle these assemblies in an ESD-safe manner. Where possible, the assemblies should be replaced in an ESD-safe location. If unable to do so, take ESD-safe precautions when replacing these. Must be transported in ESD-safe containers. The packaging of the assemblies must be ESD-safe. If possible, use the packaging of the spare part or use ESD-safe packaging.

Observe the above specifications when installing the spare part. Ensure the part and all components are properly installed. Return the cables to the original state before putting into service. When in doubt, contact the manufacturer for additional information.

