

Level switch NS 64/NS 100 ..-AM

Forging and press technology require large fluid volumes to be moved very rapidly under high overpressure. For this purpose, hydraulic accumulators are charged with the fluid up to the required operating pressure and pressurised to release the desired volume at the correct pressure at the defined time.

The NS 64 and NS 100 series are suitable for monitoring the variable fill volumes for these systems. Available with up to 64 or 100 bar pressure ratings, they indicate the desired liquid level via clearly visible sight glass float, as well as via variable switching contacts and/or continuous output position encoder. A magnetic field generated by the interior unsinkable main float moves the sight glass float. The same magnetic field also triggers the electric contacts and the position encoder.

Level switch NS for tank top installation

Visual and electric liquid level monitoring

Operating pressure up to 100 bar

Adjustable level contacts

Optional analog output 4-20 mA or IO-Link

Display with scale

Compact design

Particularly buoyant floats

Special versions available upon request

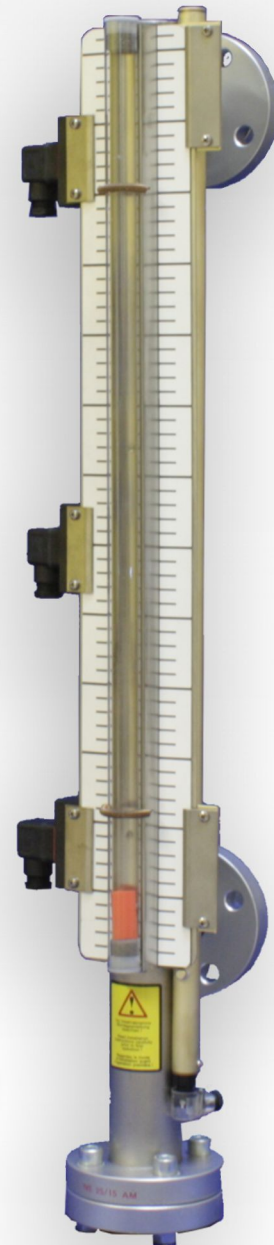

Technical Data NS 64 ..-AM

Basic unit

Max. operating pressure	64 bar
Max. operating temperature	50 °C
spec. min. fluid weight	0.85 kg/dm ³

Material

Float SK596	Plastic
Riser	1.4571
Flange	1.4541
Sight glass	PC

Connection

DIN 2637 flange	DN 25
ØD	140
Øk	100
Ød	18
b	22
ØA	68
h	2
Weight at L1=500 mm	approx. 22 kg
Weight L1+100 mm	approx. 0.5 kg

Other versions available upon request

Options

Continuous liquid level measurement BLT or switching contacts, see below

Accessories

Item no.:	Description:
2254000	Flange seal 65/25x2 mm (DN25)
2273999	Mounting bolts 8 x M16x70
9008073	Ball valve, steel DN25 PN64
9008078	Ball valve, stainless steel DN25 PN64

Pressure Equipment Directive information:

The level switches are designed, manufactured and tested to Pressure Equipment Directive 2014/68/EU according to AD-2000 code.

The actual category of the level switch achieved is printed on the type plate. Depending on the category, comprehensive quality assurance is performed according to module H or H1.

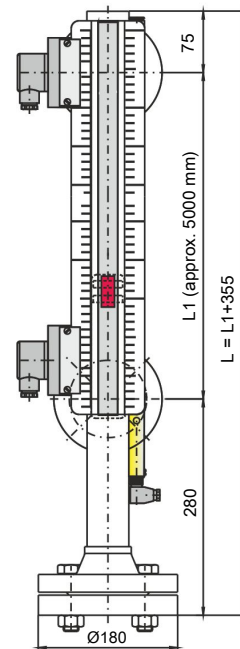
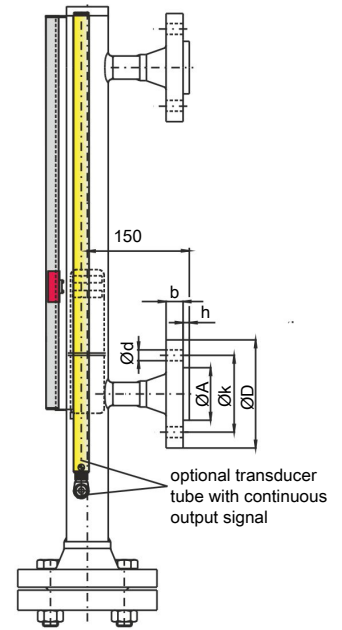

Model key NS 64

Model key

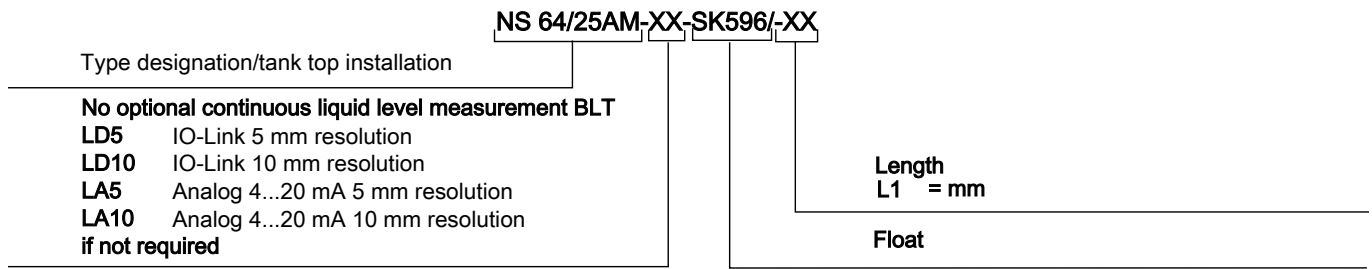

Ordering example:

You require: Level switch for external installation, max. operating pressure 64 bar, with DN25 flange connection, adapter spacing L1 = 1400 mm, with 2 changeover contacts

Order NS 64/25-AM-SK596 / 1400
2 x item no. 28 89 999; contact MKS - 1/W

Ordering example with continuous liquid level measurement:

You require: Level switch for tank top installation, max. operating pressure 64 bar, with DN25 flange connection, transducer tube IO-Link 5 mm, adapter spacing L1 = 1400 mm, with 2 changeover contacts

Order NS 64/25-AM-LD5-SK596 / 1400
2 x item no. 28 89 999; contact MKS - 1/W

Technical Data NS 100 ..-AM

Basic unit

Max. operating pressure	100 bar
Max. operating temperature	50 °C
spec. min. fluid weight	0.85 kg/dm ³

Material

Float SK596	Plastic
Riser	1.4571
Flange	1.4541
Sight glass	PC

Connection

DIN 2637 flange	DN 25
ØD	140
Øk	100
Ød	18
b	22
ØA	68
h	2
Weight at L1=500 mm	approx. 25 kg
Weight L1+100 mm	approx. 0.5 kg
<i>Other versions available upon request</i>	

Options

Continuous liquid level measurement BLT or switching contacts, see below

Accessories

Item no.:	Description:
2254000	Flange seal 65/25x2 mm (DN25)
2273999	Mounting bolts 8 x M16x70
9008077	Ball valve, steel DN25 PN100
9008079	Ball valve, stainless steel DN25 PN100

Pressure Equipment Directive information:

The level switches are designed, manufactured and tested to Pressure Equipment Directive 2014/68/EU according to AD-2000 code.

The actual category of the level switch achieved is printed on the type plate. Depending on the category, comprehensive quality assurance is performed according to module H or H1.

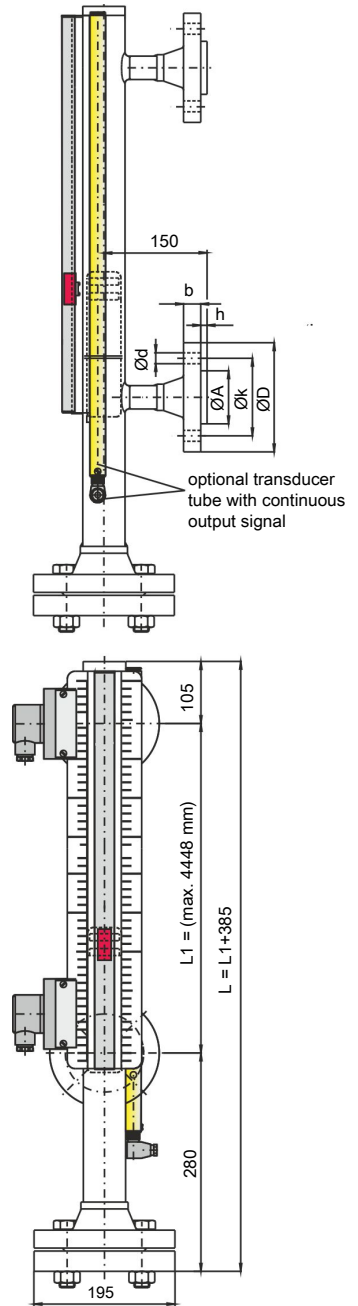

Model key NS 100

Model key

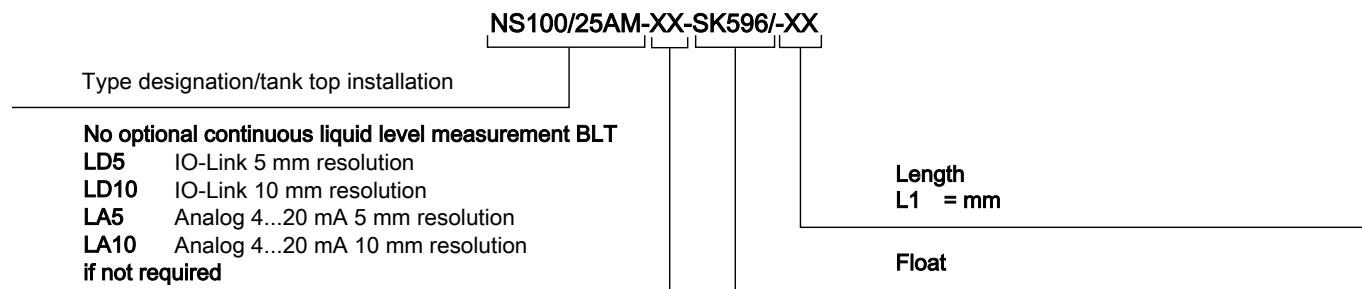

Ordering example:

You require: Level switch for external installation, max. operating pressure 100 bar, with DN25 flange connection, adapter spacing L1 = 1500 mm, continuous level output, 5 mm resolution and with 2 changeover contacts

Order NS 100/25-AM-K5-SK596 / 1500
2 x item no. 28 89 999 contact MKS 1/W

Contacts for NS ..-AM

Pin Assignment (Contact position empty tank)

Type	MKS-1/K (-60)
Function	NC contact/NO contact
Max. voltage	230 VAC/DC
Max. switching current	1 A
Max. contact load	50 VA
Connector	M3 (DIN EN 175301-803)
	3-pin + PE
IP class	IP 65
Item no.	28 88 999

Mounted left

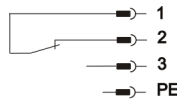

Mounted right

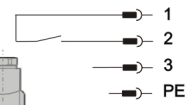

Type	MKS-2/K
Function	2 x NC contact/NO contact
Max. voltage	230 VAC/DC
Max. switching current	1 A
Max. contact load	50 VA
Connector	S6 (DIN EN 175291-804)
	6-pin + PE
IP class	IP 65
Item no.	28 91 999

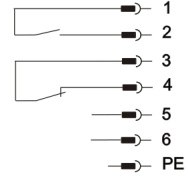
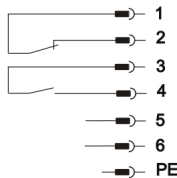

Type	MKS-1/W (-60)
Function	Changeover contact
Max. voltage	230 VAC/DC
Max. switching current	1 A
Max. contact load	50 VA
Connector	M3 (DIN EN 175301-803)
	3-pin + PE
IP class	IP 65
Item no.	28 89 999

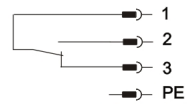
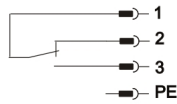

Type	MKS-1/W-L 24 V (-60)
Function	Changeover contact with LED
Max. voltage	24 VDC
Max. switching current	1 A
Max. contact load	25 VA
Connector	S6 (DIN EN 175291-804)
	6-pin + PE
IP class	IP 65
Item no.	28 90 999

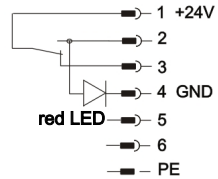
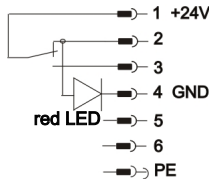

Other contacts available upon request

For applications in high shock and vibration environments we recommend using the MKS-1/K and MKS-2K contacts.

Versions ending in -60 are for switch type NS 3/20 AM and have a pipe clamp for mounting to the level switch tube.



When installing a BLT transducer tube with continuous output signal, the contacts can only be mounted on the left.

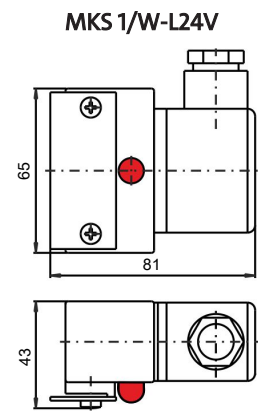
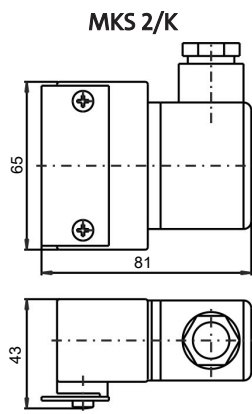
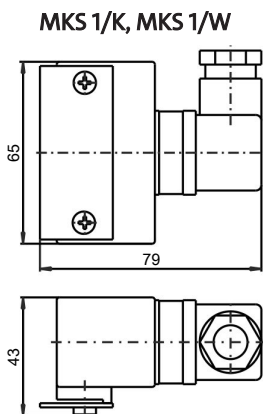

BLT Technical Data

LD-5(10)-1D1S-/VAR with IO-Link interface

LA-5(10)-1A-/VAR with 4-20 mA output

	1D1S	1A
Transducer tube material:	Nickel-plated brass	
Ambient temperature:	-20 °C to +70 °C	
Lengths:	variable to max. 5000 mm	
Input value		
Sensor element:	Reed chain 5 or 10 mm resolution	
Tolerance:	±1% FS	
Operating voltage (UB):	18 - 30 VDC	10 - 30 VDC
Measuring range:	0 to 100 %	4-20 mA > 0-100 %
Output:	IO-Link	4-20 mA
IO-Link	Rev. 1.1	-
Baudrate:	COM3 (230.4k)	-
SIO Mode:	Yes	-
Min. Time Period	10 ms	-
Max. Load:	-	(UB-8V)/0.02 A

Dimensions

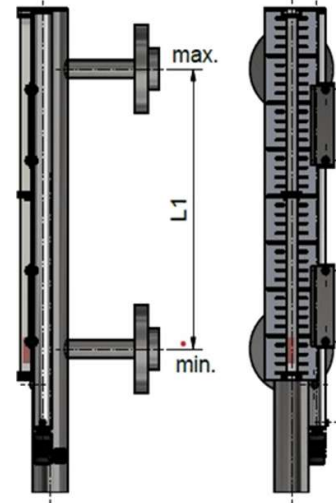

BLT Standard Pin Assignment

Connector	M12 (base)	M12 (base)
Number of pins	4-pin	4-pin
DIN EN 61076-2-101	30 VDC	30 VDC
IP rating with IP67 cable box attached	IP67	IP67
Version	1D1S	1A
Connection schematic		
	1D1S (IO-Link)	1A (4-20 mA)
1	+24 VDC	+24 VDC
2	S2 (PNP max. 200 mA)	OUT 4-20 mA
3	GND	GND
4	C/Q (IO-Link)	NC