

Level- and temperature sensor

Nivovent NV 73

The oil tank is the key component of hydraulic and lubrication systems. The operating oil is removed from the tank and then returned to it. Depending on what the system is used for, the levels in the oil tank can fluctuate to varying degrees. In most applications, the level fluctuations result in an exchange of the vapour phase above the oil level with the ambient air. Therefore, virtually all oil tanks are equipped with a so-called air breather, to prevent contaminants in the ambient air from entering the system.

To reduce costs and space requirements, a number of other system-related functions such as liquid level and temperature monitoring are also combined in the air breather in the Nivovent series.

NV 73

Connecting flange as per DIN 24557 Part 2

Qualified vent filter with replaceable element

Visual air breather monitoring optional

IO-Link and 1 x programmable switching output

Continuous liquid level and temperature measurement

Analog output 4-20 mA (2-10 V DC upon request)

Resolution 5 mm (liquid level)

Various plug options

Proven and tested highly dynamic float system

Float and immersion tube optionally available in stainless steel

Immersion tube length up to 1420 mm (longer upon request)



Technical Data NV 73

Version	MS	VA*
Operating pressure	max. 1 bar	max. 1 bar
Operating temperature	-20 °C to +80 °C	-20 °C to +80 °C
Float	SK604	SK221
Min. fluid density	0.80 kg/dm ³	0.85 kg/dm ³
Lengths (all versions)	280, 370, 500, 670, 820, 970, 1120, 1270 and 1420 mm (other lengths available upon request)	

Material/Version

Float	PU	1.4571
Immersion tube	Brass	1.4571
Flange / filter housing	PA	PA
Weight at L=280 mm	approx. 800 g	approx. 900 g
Each 100 mm add	approx. 30 g	approx. 50 g

Includes:

Mounting screws (quantity 6) and GI-cork seal.

*Not available in conjunction with FCT option

Options

Stilling tube (SSR)	Brass	VA
---------------------	-------	----

Vent filter **All versions HY type Hydac BF 7**

Filter fineness	3 µm
Additional equipment	Filler cap – n/a with filling adapter

Input values	Level	Temperature
Principle of measurement	Reed-contact	Pt100 Cl. B, DIN EN 60751
Resolution	5 mm	

Analogue version

Tolerance		± 0.8 °C
Operating voltage (U _B)	10 – 30 V DC	10 – 30 V DC
Analysis display electronics accuracy	± 1 % from end value	± 1 % from end value
Output	4-20 mA	4-20 mA (0-100 °C*) *Other ranges upon request
Burden Ω max.	$= (U_B - 7.5 \text{ V}) / 0.02 \text{ A}$	$= (U_B - 7.5 \text{ V}) / 0.02 \text{ A}$

Digital version

Ambient temperature	-20 °C to 70 °C	
Operating voltage (U _B)	18 – 30 V DC	18 – 30 V DC
Analysis display electronics accuracy	± 1 % from end value	± 1 % from end value
IO-Link version:	Revision 1.1	
Baudrate	COM3 (230.4 k)	
SIO Mode	Yes	
min. time period	10 ms	

Dimensions NV 73

Basic version

With options

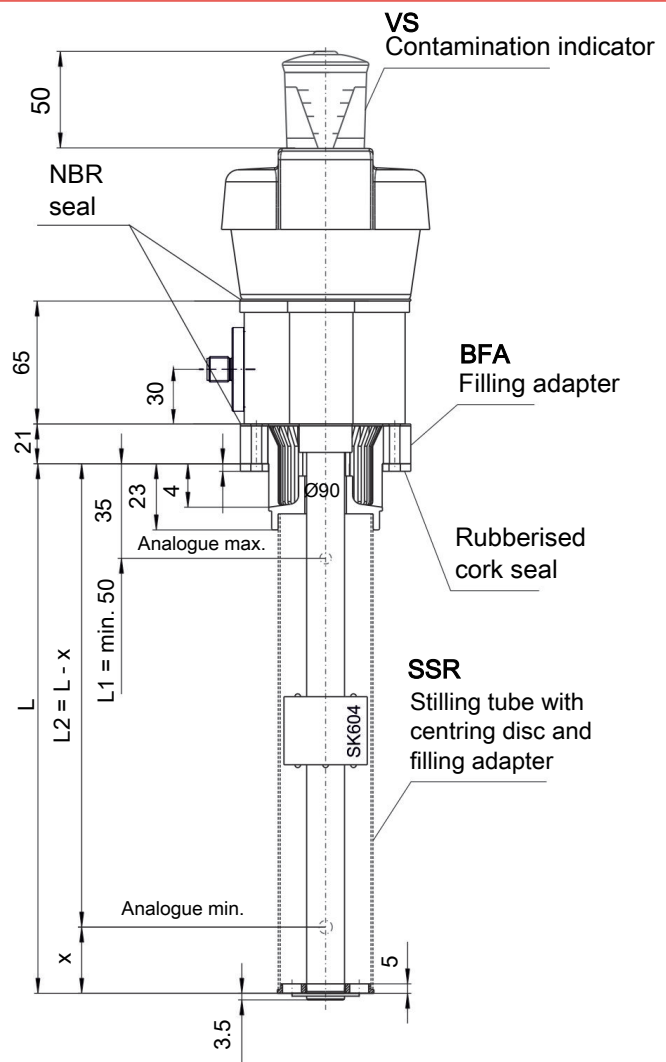
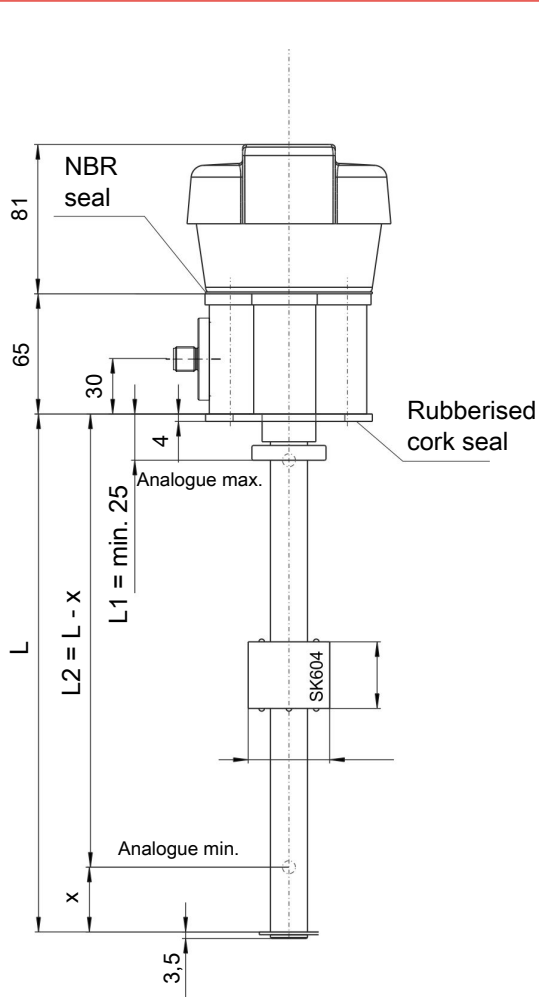

Flange drawing

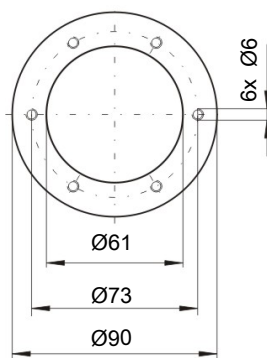

SK 604 float for NV 73-MS

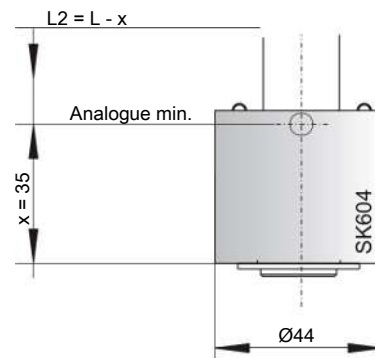

SK 221 float for NV 73-VA

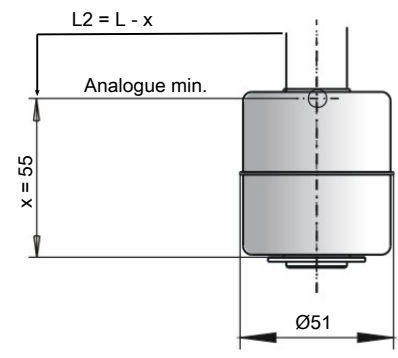

Ordering instructions NV 73

Options / Accessories

- VS** Visual air breather **clogging indicator**: Analogue underpressure indicator, display range 0.35 bar.
- BFA*** **Filling adapter** incl. ribbed flange with sieve insert: This option allows adding small oil quantities via the air breather housing. The corresponding housing is therefore equipped with that version.
- SSR*** **Stilling tube** with support ring and filling adapter: This includes the optional stilling tube as well as the same filling option as the BFA. The stilling tube is made of the same material as the requested immersion tube (MS/VS).
- MT** For integration in **Multiterminal**: The basic unit will be mounted to the Multiterminal (MT). For specification please refer to the Multiterminal data sheet.
- MTS** For integration in **Multiterminal including stilling tube**: In addition to the basic unit, a stilling tube with centring rod is installed in the Multiterminal.
- FCT** **Fluid control terminal**: Here the fluid control terminal (FCT) mounts directly onto the basic version. For details please refer to the fluid control terminal data sheet.

* not available in conjunction with FCT and MT/MTS option.

Model key

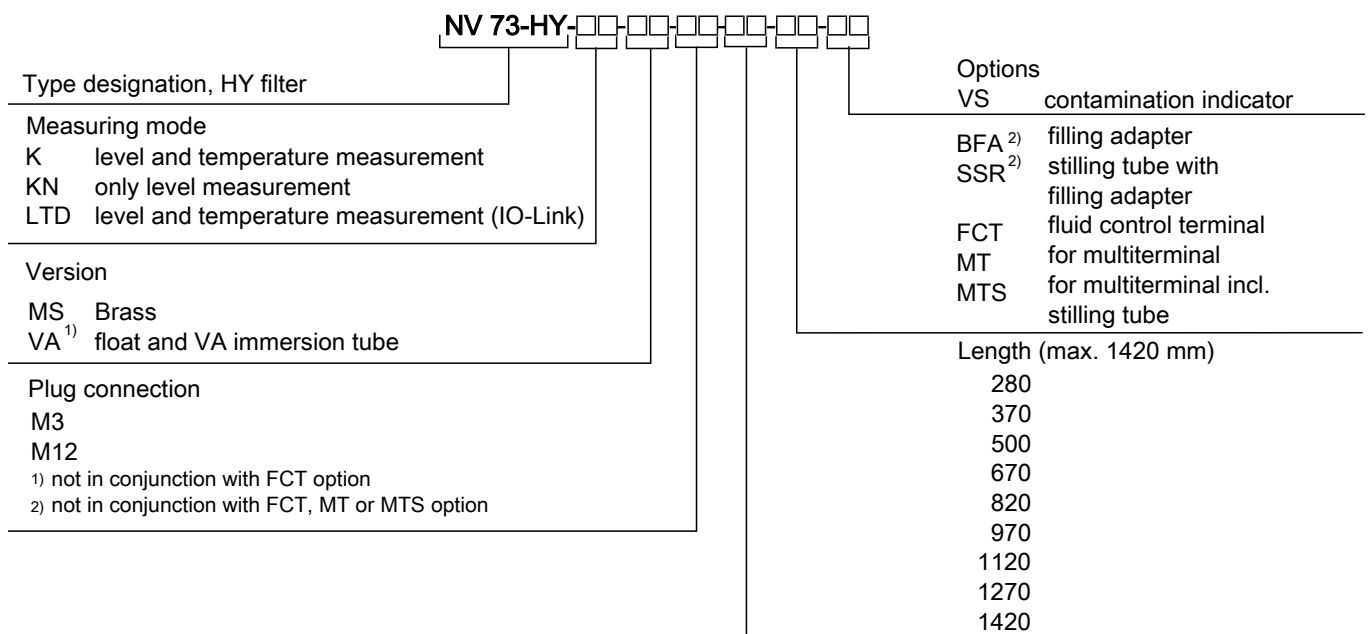

Accessories

Item no.	Description
9144 05 0010	Connecting cable M12x1, 4-pin, 1.5 m, angular coupling and straight plug
9144 05 0046	Connecting cable M12x1, 4-pin, 3.0 m, angular coupling and straight plug
9144 05 0047	Connecting cable M12x1, 4-pin, 5.0 m, angular coupling and strands

Another accessory offered is a programmable display and control unit for displaying and monitoring measured variables, see data sheet no. 180201.

Ordering example

You require:	Level and temperature measurement with vent filter, resolution 5 mm, brass version with M12 plug connection and length L = 670 mm
Order:	NV 73-HY-K-MS-M12 / 670

Standard pin assignment NV 73

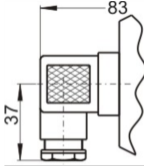
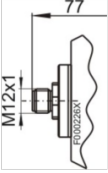
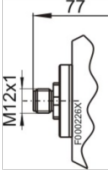
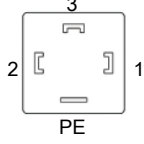
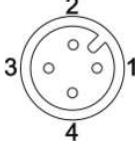
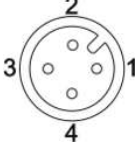
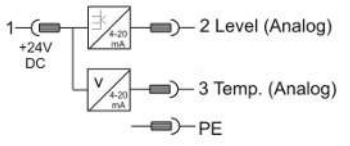
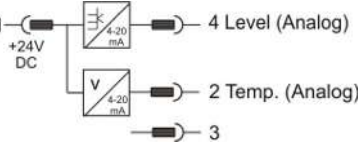
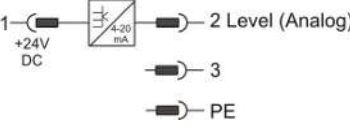
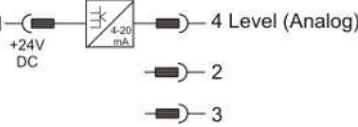
Pin assignment	M3 valve connector	M12 plug A coded	M12 plug A coded LTD style
Dimensions			
Connection schematic			
Number of pins	3-pin + PE	4-pin	4-pin
DIN EN	175301-803	61076-2-101	61076-2-101
IP rating	IP65	IP67*	IP67*
Cable fitting	PG11	-	-
K continuous level and temperature measurement			Pin 1 +24 V DC 2 S2 (PNP max. 200 mA) 3 GND 4 C/Q (IO-Link)
KN continuous level measurement			

*IP67 with cable box attached.