

Duplex Filter

Pi 210/Pi 212*

Nominal pressure 32/63 bar (460/900 psi), nominal size up to 600
* Direction of flow from right to left

1. Features

High performance filters for modern hydraulic systems

- Modular system
- Compact design
- Minimal pressure drop through optimal flow design
- Visual/electrical/electronic maintenance indicator
- Threaded connections
- Change over valve on upstream side
- Ergonomic switch-over handle with safety lock and pressure compensation
- User-optimized one-hand-operation
- Equipped with highly efficient glass fibre PS filter elements
- Beta rated elements according to ISO 16889 multipass test
- Elements with high differential pressure stability and dirt holding capacity
- Other connections on request
- Worldwide distribution



2. Flow rate/pressure drop curve complete filter

■ 190 mm²/s
■ 33 mm²/s

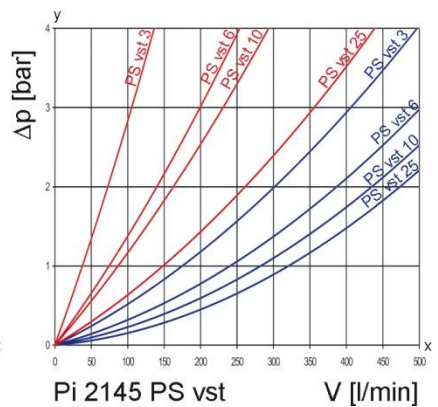
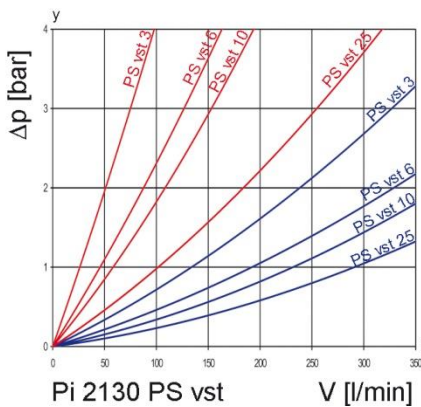
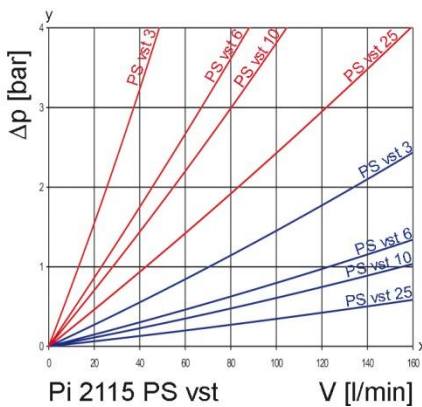
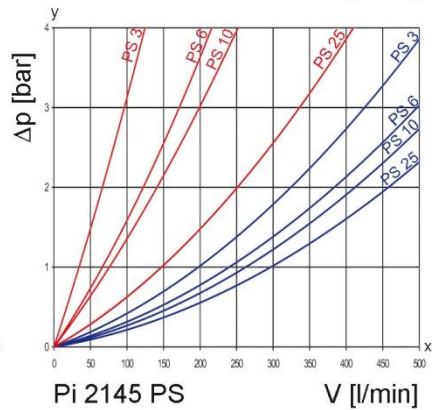
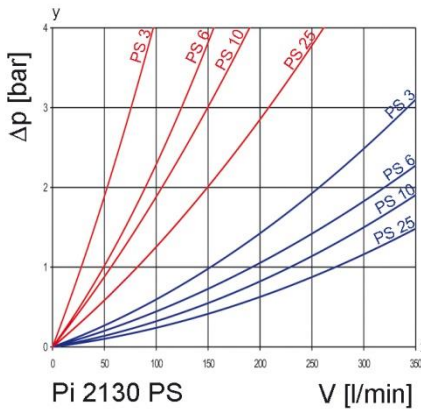
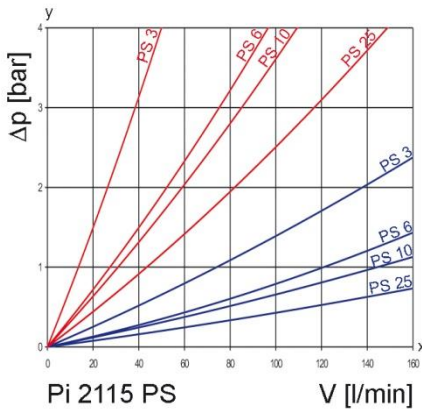
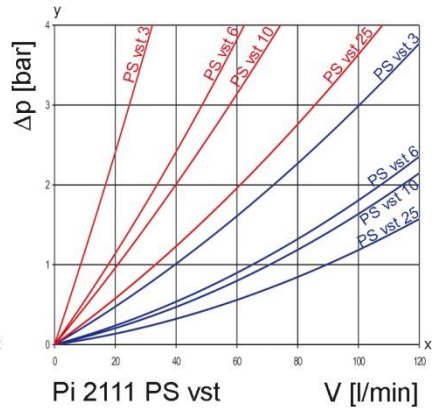
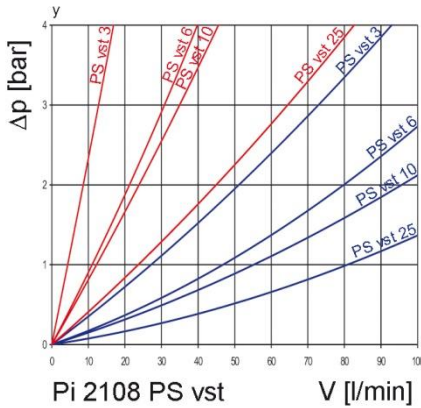
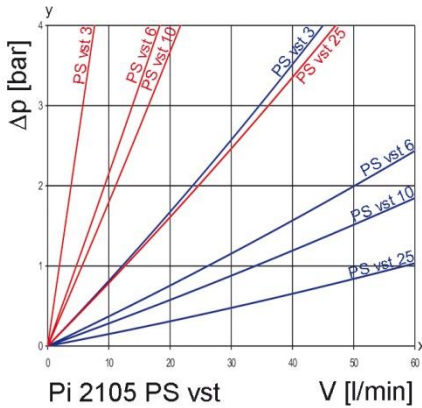
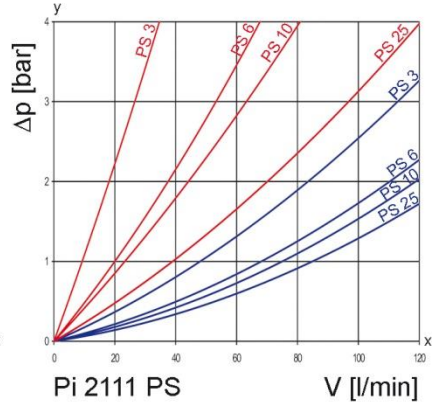
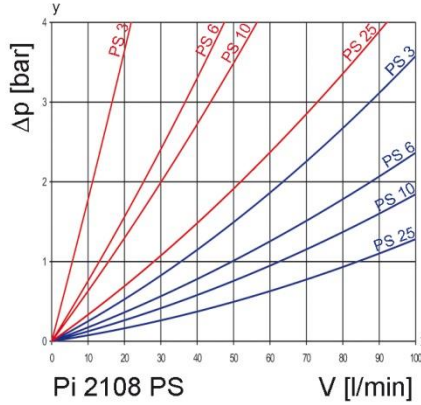
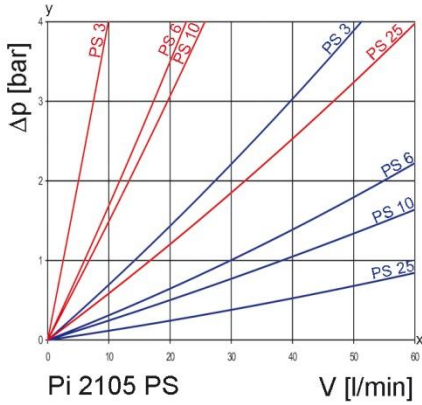

y = differential pressure Δp [bar]

x = flow rate V [l/min]

Pressure drop curves Pi 2105/Pi 2108/Pi 2111 correspond to Pi 21205/Pi 21208/Pi 21211 respectively.

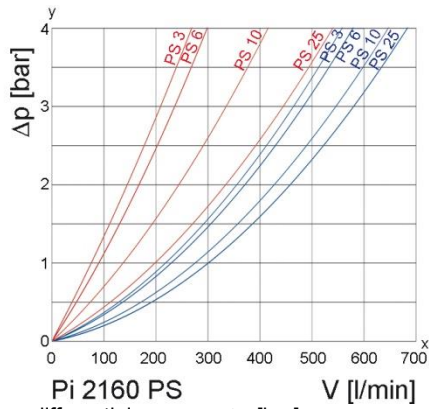

y = differential pressure Δp [bar]
 x = flow rate V [l/min]

3. Separation grade characteristics

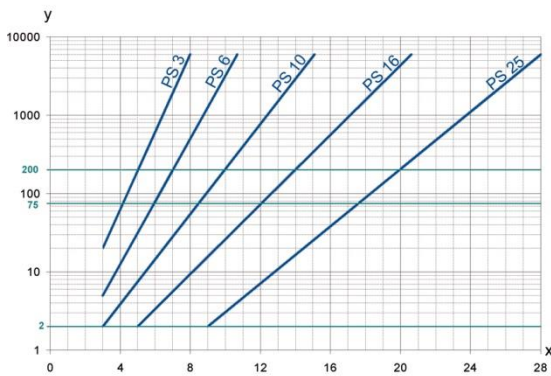

y = beta-value
 x = particle size [μm]

determined by multipass tests (ISO 16889)
 calibration according to ISO 11171 (NIST)

5. Quality assurance

Filtration Group filters and filter elements are produced according to the following international standards:

Norm	Designation
DIN ISO 2941	Hydraulic fluid power filter elements; verification of collapse/burst resistance
DIN ISO 2942	Hydraulic fluid power filter elements; verification of fabrication integrity
DIN ISO 2943	Hydraulic fluid power filter elements; verification of material compatibility with fluids
DIN ISO 3723	Hydraulic fluid power filter elements; method for end load test
DIN ISO 3724	Hydraulic fluid power filter elements; verification of flow fatigue characteristics
ISO 3968	Hydraulic fluid power-filters-evaluation of pressure drop versus flow characteristics
ISO 10771.1	Fatigue pressure testing of metal containing envelopes in hydraulic fluid applications
ISO 16889	Hydraulic fluid power filters-multipass method for evaluation filtration performance of a filter element

4. Filter performance data

tested according to ISO 16889 (multipass test)

PS elements with max. Δp 20 bar		PS vst elements with max. Δp 210 bar	
PS	3 $\beta_{5(C)}$ ≥ 200	PS vst	3 $\beta_{5(C)}$ ≥ 200
PS	6 $\beta_{7(C)}$ ≥ 200	PS vst	6 $\beta_{7(C)}$ ≥ 200
PS	10 $\beta_{10(C)}$ ≥ 200	PS vst	10 $\beta_{10(C)}$ ≥ 200
PS	25 $\beta_{20(C)}$ ≥ 200	PS vst	25 $\beta_{20(C)}$ ≥ 200

values guaranteed up to 10 bar differential pressure

values guaranteed up to 20 bar differential pressure

6. Symbols

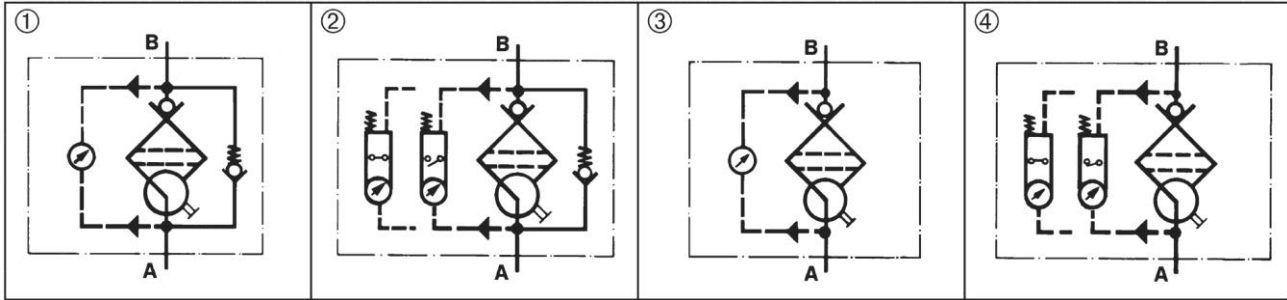

7. Order numbers

Example for ordering filters:

1. Housing design	2. Filter element
V = 80 l/min and visual/electrical indicator Type: Pi 2108-069 Order number: 77810286	PS vst 3 Type: Pi 2208 PS vst 3 Order number: 77680200

7.1 Housing design						
Nominal size NG [l/min]	Order number	Type	① with bypass valve and visual indicator	② with bypass valve and electrical indicator	③ with visual indicator	④ with electrical indicator
50	77810211	Pi 2105-057				
	77810229	Pi 2105-058				
	77810237	Pi 2105-068				
	77810245	Pi 2105-069				
80	77810252	Pi 2108-057				
	77810260	Pi 2108-058				
	77810278	Pi 2108-068				
	77810286	Pi 2108-069				
110	78204083	Pi 2111-057				
	78204091	Pi 2111-058				
	78204109	Pi 2111-068				
	78204117	Pi 2111-069				
150	77774573	Pi 2115-057				
	77774565	Pi 2115-058				
	77774557	Pi 2115-068				
	77774540	Pi 2115-069				
300	77774532	Pi 2130-057				
	77774524	Pi 2130-058				
	77774516	Pi 2130-068				
	77774508	Pi 2130-069				
450	77774490	Pi 2145-057				
	77774482	Pi 2145-058				
	77774474	Pi 2145-068				
	77774466	Pi 2145-069				
600	70574769	Pi 2160-057				
	70574768	Pi 2160-058				
	70574767	Pi 2160-068				
	70574766	Pi 2160-069				

When filter with non bypass configuration is selected, the collapse pressure of the element must not be exceeded.

Housing versions Pi 212 on request.

7.2 Filter elements *					
Nominal size NG [l/min]	Order number	Type	Filter material	max. Δp [bar]	Filter surface [cm ²]
50	77680135	Pi 2105 PS 3	PS 3	20	590
	77943509	Pi 5105 PS 6	PS 6		590
	77680325	Pi 3105 PS 10	PS 10		590
	77680440	Pi 4105 PS 25	PS 25		590
	77680192	Pi 2205 PS vst 3	PS vst 3	210	425
	77943533	Pi 5205 PS vst 6	PS vst 6		425
	77680382	Pi 3205 PS vst 10	PS vst 10		425
	77680507	Pi 4205 PS vst 25	PS vst 25		425
80	77680143	Pi 2108 PS 3	PS 3	20	1150
	77943517	Pi 5108 PS 6	PS 6		1150
	77680341	Pi 3108 PS 10	PS 10		1150
	77680457	Pi 4108 PS 25	PS 25		1150
	77680200	Pi 2208 PS vst 3	PS vst 3	210	850
	77943541	Pi 5208 PS vst 6	PS vst 6		850
	77681190	Pi 3208 PS vst 10	PS vst 10		850
	77680515	Pi 4208 PS vst 25	PS vst 25		850
110	77680150	Pi 2111 PS 3	PS 3	20	1700
	77943525	Pi 5111 PS 6	PS 6		1700
	77680333	Pi 3111 PS 10	PS 10		1700
	77680465	Pi 4111 PS 25	PS 25		1700
	77680218	Pi 2211 PS vst 3	PS vst 3	210	1275
	77943558	Pi 5211 PS vst 6	PS vst 6		1275
	77680390	Pi 3211 PS vst 10	PS vst 10		1275
	77680523	Pi 4211 PS vst 25	PS vst 25		1275
150	77680168	Pi 2115 PS 3	PS 3	20	2425
	77955099	Pi 5115 PS 6	PS 6		2425
	77680358	Pi 3115 PS 10	PS 10		2425
	77680473	Pi 4115 PS 25	PS 25		2425
	77680226	Pi 2215 PS vst 3	PS vst 3	210	2010
	77955123	Pi 5215 PS vst 6	PS vst 6		2010
	77680408	Pi 3215 PS vst 10	PS vst 10		2010
	77680531	Pi 4215 PS vst 25	PS vst 25		2010
300	77680176	Pi 2130 PS 3	PS 3	20	4620
	77955107	Pi 5130 PS 6	PS 6		4620
	77680366	Pi 3130 PS 10	PS 10		4620
	77680481	Pi 4130 PS 25	PS 25		4620
	77680234	Pi 2230 PS vst 3	PS vst 3	210	3800
	77955131	Pi 5230 PS vst 6	PS vst 6		3800
	77680416	Pi 3230 PS vst 10	PS vst 10		3800
	77680549	Pi 4230 PS vst 25	PS vst 25		3800
450	77680184	Pi 2145 PS 3	PS 3	20	6865
	77955115	Pi 5145 PS 6	PS 6		6865
	77680374	Pi 3145 PS 10	PS 10		6865
	77680499	Pi 4145 PS 25	PS 25		6865
	77680242	Pi 2245 PS vst 3	PS vst 3	210	5600
	77955149	Pi 5245 PS vst 6	PS vst 6		5600
	77680424	Pi 3245 PS vst 10	PS vst 10		5600
	77680556	Pi 4245 PS vst 25	PS vst 25		5600

* a wider range of element types is available on request

7.2 Filter elements *					
Nominal size NG [l/min]	Order number	Type	Filter material	max. Δp [bar]	Filter surface [cm ²]
600	70346506	Pi 2160 PS 3	PS 3	20	9398
	76114318	Pi 5160 PS 6	PS 6		9398
	79393380	Pi 3160 PS 10	PS 10		9398
	79748047	Pi 4160 PS 25	PS 25		9398

* a wider range of element types is available on request

8. Technical specifications

Design:	line mounting filter
Nominal pressure:	
Pi 2105 - Pi 2111	10 ⁷ load changes
Pi 21205 – Pi 21211	63 bar (900 psi)
Pi 2115 - Pi 2160	10 ⁷ load changes
	25 bar (360 psi)
	2x 10 ⁶ load changes
	32 bar (460 psi)
Test pressure:	
Pi 2105 - Pi 2111	
Pi 21205 – Pi 21211	95 bar (1370 psi)
Pi 2115 - Pi 2160	48 bar (690 psi)
Temperature range:	-10 °C to +120 °C
	survival temperature -40 °C
	(other temperature ranges on request)
Bypass setting:	Δp 3.5 bar \pm 10 %
Filter head material:	GAL
Filter housing material:	AL/St
Sealing material:	NBR/AL
Maintenance indicator setting	Δp 2.2 bar \pm 10 %
Electrical data of maintenance indicator:	
Max. voltage:	250 V AC/200 V DC
Max. current:	1 A
Contact load:	70 W
Type of protection:	IP 65 in inserted and secured status
Contact:	normally open/closed
Cable connection:	M20x1.5

The switching function can be changed by turning the electric upper part by 180° (normally closed contact or normally open contact). The state on delivery is a normally closed contact. By inductivity in the direct current circuit the use of suitable protection circuit should be considered. Further maintenance indicator details and designs are available in the maintenance indicator data sheet.

We draw attention to the fact that all values indicated are average values which do not always occur in specific cases of application. Our products are continually being further developed. Values, dimensions and weights can change as a result of this. Our specialized department will be pleased to offer you advice.

We recommend to contact us concerning applications of our filters in areas governed by the EU Directive 94/9 EC (ATEX 95). The standard version can be used for liquids based on mineral oil (corresponding to the fluids in Group 2 of Directive 97/23 EC Article 9). If you consider to use other fluids please contact us for additional support.

Subject to technical alteration without prior notice.

9. Dimensions

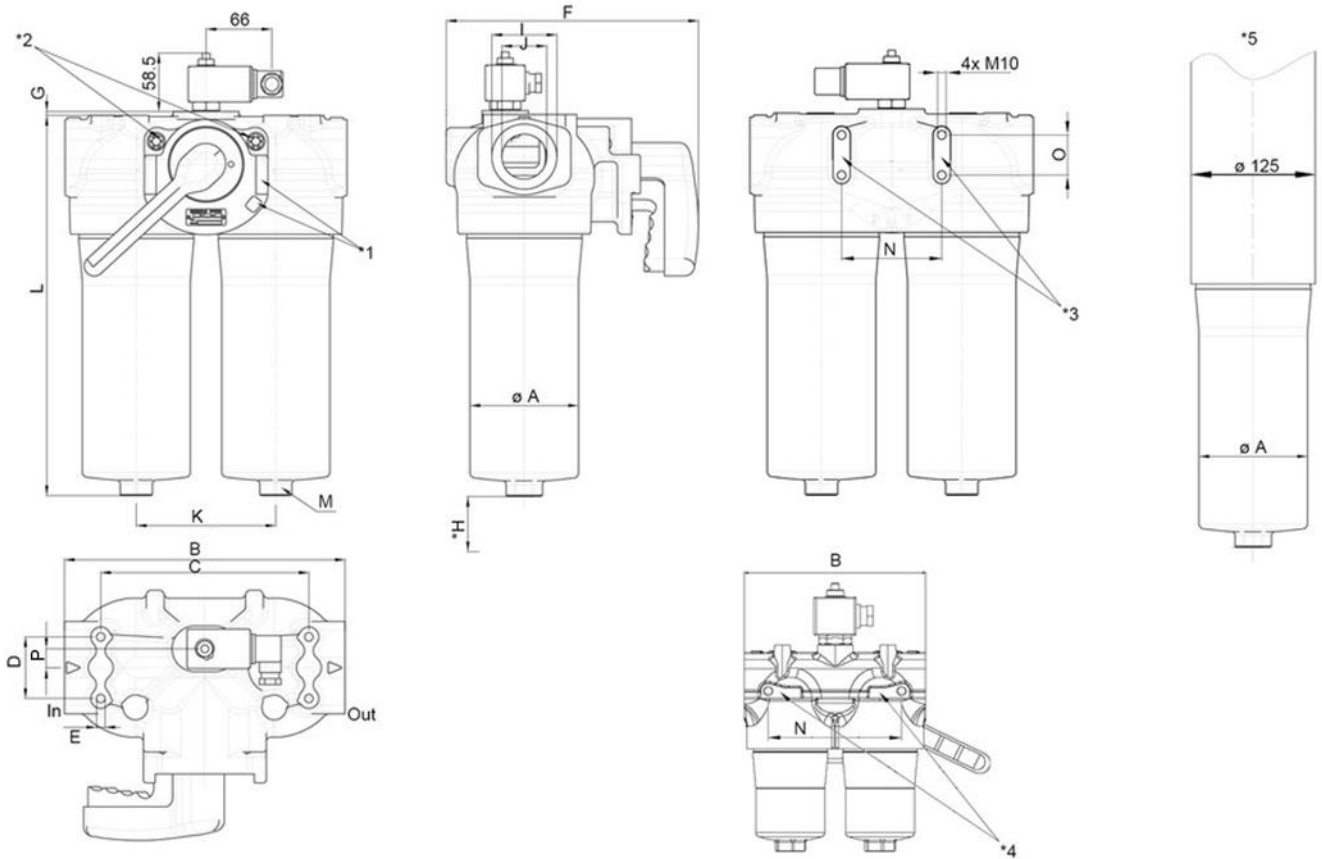

- In Inlet
- Out Outlet
- *H Minimum clearance required for element change
- *1 Lever locking and arresting
- *2 Venting screws

- *3 Optional fixing for NG 150 to 600 (WB version)
- *4 Optional fixing for NG 50 to 110 (WB version)
- *5 Housing version for NG 600

All dimensions except "J" in mm

Type	A	B	C	D	E	F	G	H	I	J*	K	L**	M SW	N	O	P	Wt. [kg]
Pi 2105	66	172	100	52	M8x16	189	-	80	47	G1	85	203	27	128	-	16	2.60
Pi 2108	66	172	100	52	M8x16	189	-	80	47	G1	85	261	27	128	-	16	2.90
Pi 2111	66	172	100	52	M8x16	189	-	80	47	G1	85	351	27	128	-	16	3.30
Pi 2115	109	283	210	62	M10x20	252	4	110	65	G1½	140	264	32	100	40	19	8.50
Pi 2130	109	283	210	62	M10x20	252	4	110	65	G1½	140	385	32	100	40	19	9.50
Pi 2145	109	283	210	62	M10x20	252	4	110	65	G1½	140	497	32	100	40	19	17.25
Pi 2160	109	283	210	62	M10x20	252	4	110	65	G1½	140	636	32	100	40	19	15.50

* SAE flange connections (3000 psi), NPT and SAE connections on request

** Not shown drain screw at NG 450 and NG 600 is part of dimension "L"

Dimensions Pi 21205/Pi 21208/Pi 21211 on request.

10. Installation, operating and maintenance instructions

10.1 Filter installation

When installing the filter make sure that sufficient space is available to remove filter element and filter housing. Preferably the filter should be installed with the filter housing pointing downwards. The maintenance indicator must be visible.

10.2 Connecting the electrical maintenance indicator

The electrical indicator is connected via a 2-pole appliance plug according to DIN EN 175301-803 with poles marked 1 and 2. The electrical section can be inverted to change from normally open position to normally closed position or vice versa. The state on delivery is a normally closed contact.

10.3 When should the filter element be replaced?

1. During cold starts, the indicator may give a warning signal. Press the red button of the visual indicator once again only after operating temperature has been reached. If the red button immediately pops up again and/or the electrical signal has not switched off after reaching operating temperature, the filter element must be replaced after the end of the shift.
2. Please always ensure that you have original Filtration Group spare elements cleaned.

10.4 Element replacement

Note: Elements may only be replaced by people who are familiar with the function of the filter. When replacing elements, appropriate safety clothing (protective goggles, gloves, safety shoes) must be worn.

Note: The maintenance indicator monitors the filter side in operation, which is identified by the position of the switching lever catch. The change-over transfer valve must be switched prior filter servicing. Now the signal of the maintenance indicators cancelled and the red button can be repressed again.

1. Operate and hold pressure equalizing lever located behind switching lever. Pull catch knob and swivel switching lever. Engage the catch on the clear filter side. Place through or drip pan underneath to collect leaving oil..
2. Loosen vent screw of the filter side not in use by 2-3 turns; max. until contact is made with the safety stop.
3. Unscrew filter housing by rotating same counter-clockwise and clean with a suitable medium.
Warning: The shift lever may not, from now until the screwing back in of the filter housing (7.), be activated under any circumstances!
4. Remove the filter element by gently moving it back and forth downwards.
5. Check O-ring on the filter house for damage. Replace, if necessary.
6. Make sure that the order number on the spare element corresponds to the order number of the filter name-plate.
7. Lightly lubricate the threads of the filter housing and screw into the filter head. Maximum tightening torque for NG 50 to 110 = 30 Nm, for NG 150 to 600 = 50 Nm.
8. To refill the filter chamber, operate only the pressure equalizing lever (leave the switching lever arrested in its catch) long enough for the medium to emerge bubble-free from the vent bore.
9. Tighten vent screw. Check filter for leaks by operating the pressure equalizing lever once again.

11. Spare parts list

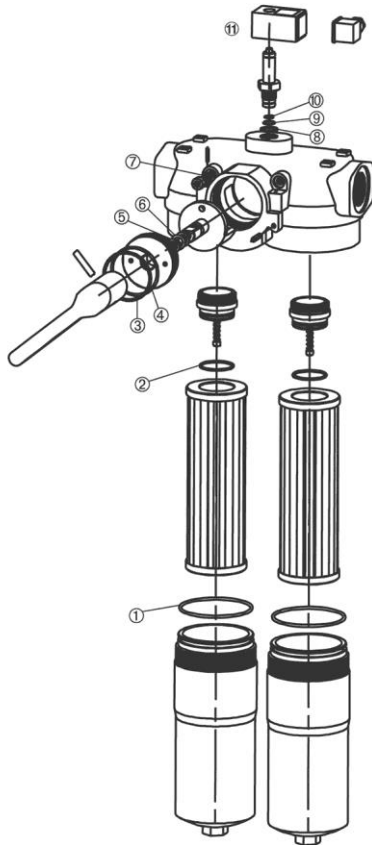

Order number for spare parts		
Position	Type	Order number
① - ⑦	Seal kit for housing	
	Pi 2105 - Pi 2111	
	Pi 21205 – Pi 21211	
	NBR	79761271
	FPM	79761289
	EPDM	79761297
	Pi 2115 - Pi 2160	
NBR	79761230	
FPM	79761248	
EPDM	79761255	
⑧ - ⑩	Seal kit for maintenance indicator	
	NBR	77760309
	FPM	77760317
EPDM	77760325	
⑪	Maintenance indicator	
	Visual PiS 3098/2.2	77669971
	Electrical PiS 3097/2.2	77669948
	Electrical upper section only	77536550