

Duplex Filter Pi 370

Nominal pressure 200/210/250/315 bar (2900/3040/3620/4570 psi), nominal size up to 450

1. Features

High performance filters for modern hydraulic systems

- Modular system
- Compact design
- Minimal pressure drop through optimal flow design
- Visual/electrical/electronic maintenance indicator
- Threaded connections
- Change over valve on upstream side
- Ergonomic switch-over handle with safety lock and pressure compensation
- User-optimized one-hand-operation
- Equipped with highly efficient glass-fibre PS filter elements
- Beta rated elements according to ISO 16889 multipass test
- Elements with high differential pressure stability and dirt holding capacity
- NPT- and SAE-connections on request
- Worldwide distribution



2. Flow rate/pressure drop curve complete filter

■ 190 mm²/s
■ 33 mm²/s

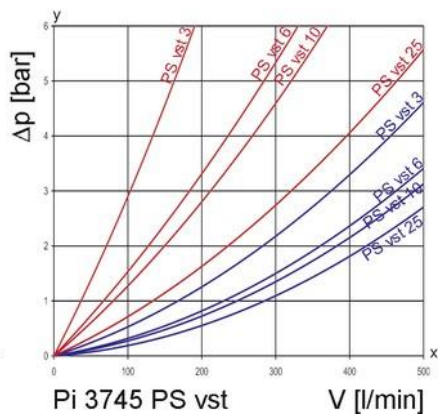
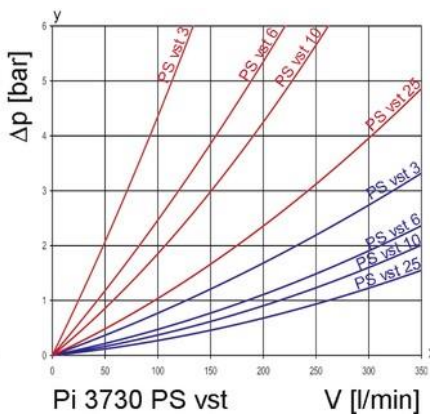
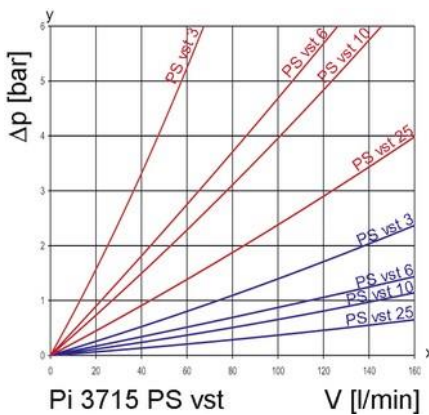
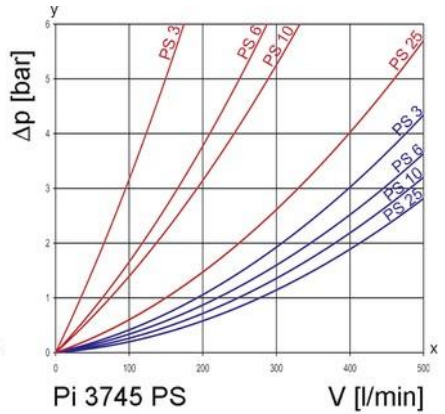
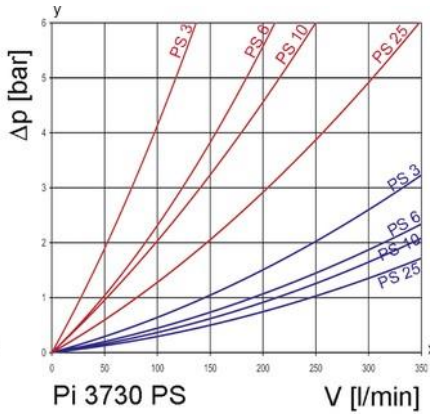
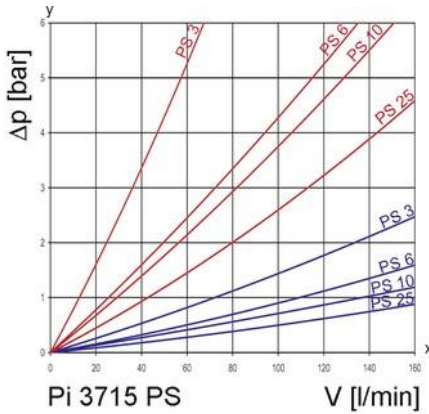
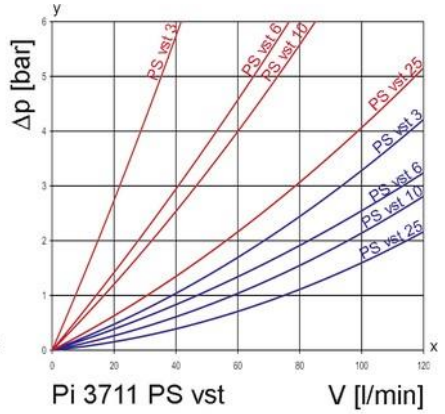
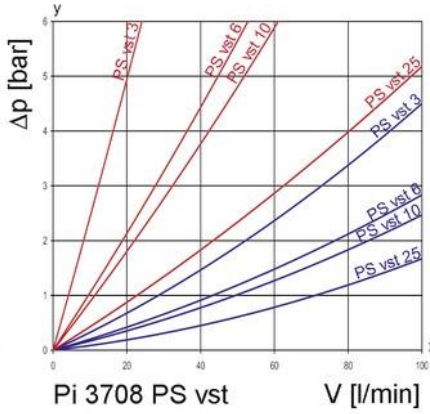
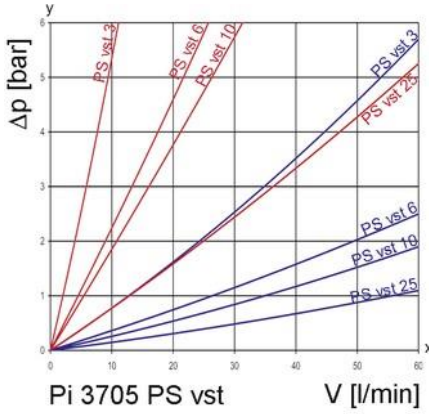
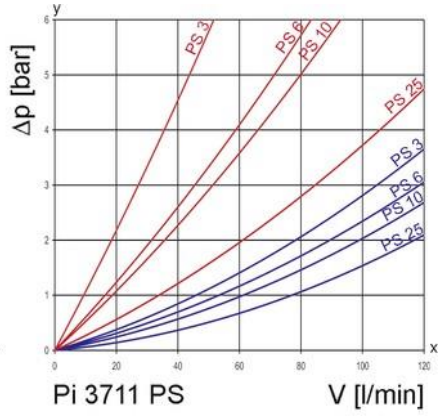
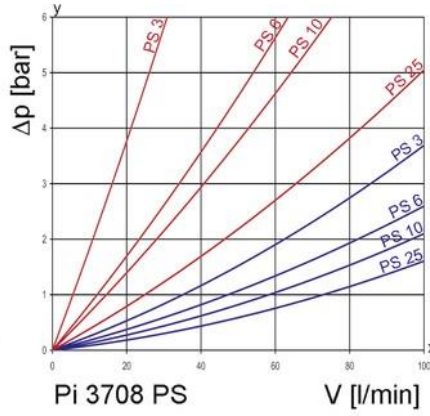
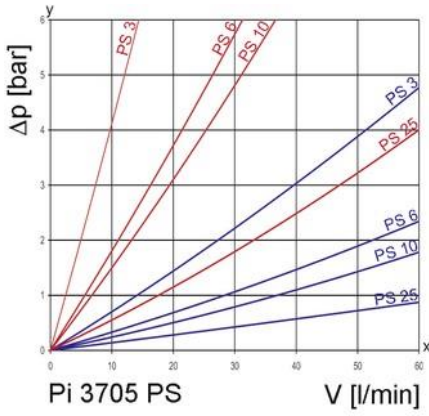

y = differential pressure Δp [bar]
 x = flow rate V [l/min]

3. Separation grade characteristics

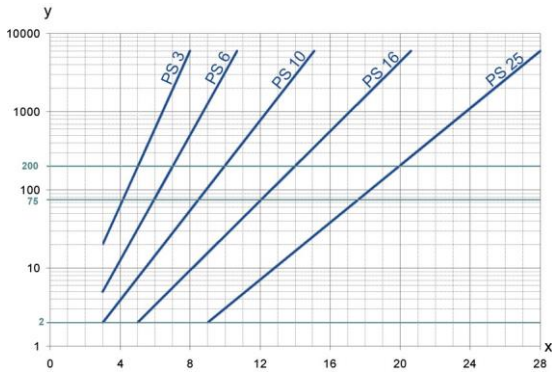

y = beta-value
x = particle size [μm]

determined by multipass tests (ISO 16889)
calibration according to ISO 11171 (NIST)

5. Quality assurance

Filtration Group filters and filter elements are produced according to the following international standards:

Norm	Designation
DIN ISO 2941	Hydraulic fluid power filter elements; verification of collapse/burst pressure
DIN ISO 2942	Hydraulic fluid power filter elements; verification of fabrication integrity
DIN ISO 2943	Hydraulic fluid power filter elements; verification of material compatibility with fluids
DIN ISO 3723	Hydraulic fluid power filter elements; method for end load test
DIN ISO 3724	Hydraulic fluid power filter elements; verification of flow fatigue characteristics
ISO 3968	Hydraulic fluid power filter; evaluation of pressure drop versus flow characteristics
ISO 10771.1	Fatigue pressure testing of metal containing envelopes in hydraulic fluid applications
ISO 16889	Hydraulic fluid power filters; multipass method for evaluation filtration performance of a filter element

6. Symbols

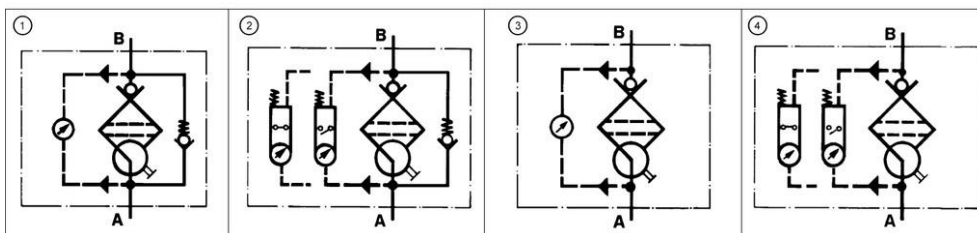

4. Filter performance data

tested according to ISO 16889 (multipass test)

PS elements with
max. Δp 20 bar

PS 3 $\beta_{5(C)} \geq 200$
PS 6 $\beta_{7(C)} \geq 200$
PS 10 $\beta_{10(C)} \geq 200$
PS 25 $\beta_{20(C)} \geq 200$

values guaranteed up to
10 bar differential pressure

PS vst elements with
max. Δp 210 bar

PS vst 3 $\beta_{5(C)} \geq 200$
PS vst 6 $\beta_{7(C)} \geq 200$
PS vst 10 $\beta_{10(C)} \geq 200$
PS vst 25 $\beta_{20(C)} \geq 200$

values guaranteed up to
20 bar differential pressure

7. Order numbers

Example for ordering filters:

1. Filter housing	2. 2x Filter element
V = 80 l/min and electrical maintenance indicator Type: Pi 3708-015 Order number: 77810369	PS vst 3 Type: Pi 2208 PS vst 3 Order number: 77680200

7.1 Housing design						
Nominal size NG [l/min]	Order number	Type	① with bypass valve and visual indicator	② with bypass valve and electrical indicator	③ with visual indicator	④ with electrical indicator
50	77810294	Pi 3705-012				
	77810302	Pi 3705-013				
	77810310	Pi 3705-014				
	77810328	Pi 3705-015				
80	77810336	Pi 3708-012				
	77810344	Pi 3708-013				
	77810351	Pi 3708-014				
	77810369	Pi 3708-015				
110	77810377	Pi 3711-012				
	77810385	Pi 3711-013				
	77810393	Pi 3711-014				
	77810401	Pi 3711-015				
150	77810419	Pi 3715-012				
	77810427	Pi 3715-013				
	77810435	Pi 3715-014				
	77810443	Pi 3715-015				
300	77810450	Pi 3730-012				
	77810468	Pi 3730-013				
	77810476	Pi 3730-014				
	77810484	Pi 3730-015				
450	77810492	Pi 3745-012				
	77814403	Pi 3745-013				
	77814411	Pi 3745-014				
	77814429	Pi 3745-015				

When filter with non bypass configuration is selected, the collapse pressure of the element must not be exceeded.

7.2 Filter elements (a wider range of element types is available on request)

Nominal size NG [l/min]	Order number	Type	Filter material	max. Δp [bar]	Filter surface [cm ²]
50	77680135	Pi 2105 PS 3	PS 3	20	590
	77943509	Pi 5105 PS 6	PS 6		590
	77680325	Pi 3105 PS 10	PS 10		590
	77680440	Pi 4105 PS 25	PS 25		590
	77680192	Pi 2205 PS vst 3	PS vst 3	210	425
	77943533	Pi 5205 PS vst 6	PS vst 6		425
	77680382	Pi 3205 PS vst 10	PS vst 10		425
	77680507	Pi 4205 PS vst 25	PS vst 25		425
80	77680143	Pi 2108 PS 3	PS 3	20	1150
	77943517	Pi 5108 PS 6	PS 6		1150
	77680341	Pi 3108 PS 10	PS 10		1150
	77680457	Pi 4108 PS 25	PS 25		1150
	77680200	Pi 2208 PS vst 3	PS vst 3	210	850
	77943541	Pi 5208 PS vst 6	PS vst 6		850
	77681190	Pi 3208 PS vst 10	PS vst 10		850
	77680515	Pi 4208 PS vst 25	PS vst 25		850
110	77680150	Pi 2111 PS 3	PS 3	20	1700
	77943525	Pi 5111 PS 6	PS 6		1700
	77680333	Pi 3111 PS 10	PS 10		1700
	77680465	Pi 4111 PS 25	PS 25		1700
	77680218	Pi 2211 PS vst 3	PS vst 3	210	1275
	77943558	Pi 5211 PS vst 6	PS vst 6		1275
	77680390	Pi 3211 PS vst 10	PS vst 10		1275
	77680523	Pi 4211 PS vst 25	PS vst 25		1275
150	77680168	Pi 2115 PS 3	PS 3	20	2425
	77955099	Pi 5115 PS 6	PS 6		2425
	77680358	Pi 3115 PS 10	PS 10		2425
	77680473	Pi 4115 PS 25	PS 25		2425
	77680226	Pi 2215 PS vst 3	PS vst 3	210	2010
	77955123	Pi 5215 PS vst 6	PS vst 6		2010
	77680408	Pi 3215 PS vst 10	PS vst 10		2010
	77680531	Pi 4215 PS vst 25	PS vst 25		2010
300	77680176	Pi 2130 PS 3	PS 3	20	4620
	77955107	Pi 5130 PS 6	PS 6		4620
	77680366	Pi 3130 PS 10	PS 10		4620
	77680481	Pi 4130 PS 25	PS 25		4620
	77680234	Pi 2230 PS vst 3	PS vst 3	210	3800
	77955131	Pi 5230 PS vst 6	PS vst 6		3800
	77680416	Pi 3230 PS vst 10	PS vst 10		3800
	77680549	Pi 4230 PS vst 25	PS vst 25		3800
450	77680184	Pi 2145 PS 3	PS 3	20	6865
	77955115	Pi 5145 PS 6	PS 6		6865
	77680374	Pi 3145 PS 10	PS 10		6865
	77680499	Pi 4145 PS 25	PS 25		6865
	77680242	Pi 2245 PS vst 3	PS vst 3	210	5600
	77955149	Pi 5245 PS vst 6	PS vst 6		5600
	77680424	Pi 3245 PS vst 10	PS vst 10		5600
	77680556	Pi 4245 PS vst 25	PS vst 25		5600

8. Technical specifications

Design:	line mounting filter
Operating pressure:	
Pi 3705 - Pi 3711	10 ⁷ load changes 250 bar (3620 psi)
	10 ⁶ load changes 315 bar (4570 psi)
Pi 3715 - Pi 3745	2x 10 ⁶ load changes 210 bar (3040 psi)
Test pressure:	
Pi 3705 - Pi 3711	450 bar (6520 psi)
Pi 3715 - Pi 3745	300 bar (4350 psi)
Pi 3705 - Pi 3745 when use on ships operating/test pressure	200/260 bar (2900/3770 psi)
Temperature range:	-10 °C to +120 °C (other temperature ranges on request)
Bypass opening pressure:	Δp 7 bar \pm 10 %
Filter head material:	GGG
Filter bowl material:	St
Sealing material:	NBR/PTFE
Activating pressure of optical/electrical differential pressure indicator	Δp 5 bar \pm 10 %
Electrical data of contamination indicator:	
Maximum voltage:	250 V AC/200 V DC
Maximum current on contact:	1 A
Inrush current:	70 W
Type of protection:	IP 65 when inserted and secured
Contact:	bistable
Cable connection:	M20x1.5

The switching function can be changed by turning the electric upper part by 180° (normally closed contact or normally open contact). The state on delivery is a normally closed contact. The use of quenching circuits must be checked in the case of inductivity in the DC current circuit. The contamination indicator data sheet contains further information and additional contamination indicator versions.

We draw attention to the fact that all values indicated are average values which do not always occur in specific cases of application. Our products are continually being further developed. Values, dimensions and weights can change as a result of this. Our specialized department will be pleased to offer you advice.

We recommend you to contact us concerning applications of our filters in areas governed by the EU Directive 94/9 EC (ATEX 95). The standard version can be used for liquids based on mineral oil (corresponding to the fluids in Group 2 of Directive 97/23 EC Article 9). If you consider to use other fluids please contact us for additional support.

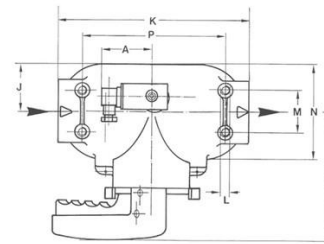
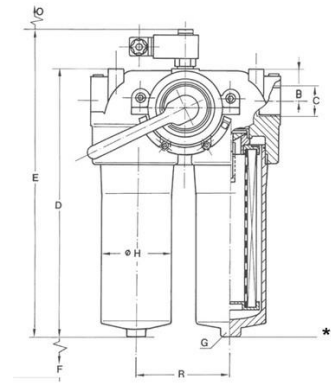

*1 Pi 3730-Pi 3745 with drain screw G ¼ DIN 910

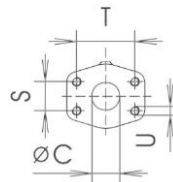

9. Dimensions

All dimensions except "C" in mm.

Type	A	B	C*	D	E	F	Weight [kg]
Pi 3705	78	38	G1	219	271	80	11.0
Pi 3708	78	38	G1	294	346	80	12.0
Pi 3711	78	38	G1	370	422	80	15.0
Pi 3715	78	50	G1½	302	354	110	31.5
Pi 3730	78	50	G1½	427	479	110	37.0
Pi 3745	78	50	G1½	543	595	110	41.5

* SAE flange connection on request.

Subject to technical alteration without prior notice.

Type	G SW	H	I	J	K	L	M	N	O	P	R	S	T	U	Weight [kg]
Pi 3705	27	65	144	45	182	M8x15	55	90	45	100	86	-	-	-	11.0
Pi 3708	27	65	144	45	182	M8x15	55	90	45	100	86	-	-	-	12.0
Pi 3711	27	65	144	45	182	M8x15	55	90	45	100	86	-	-	-	15.0
Pi 3715	30	110	175	70	280	M12x18	62	140	45	210	136	-	-	-	31.5
Pi 3730	30	110	175	70	280	M12x18	62	140	45	210	136	-	-	-	37.0
Pi 3745	30	110	175	70	280	M12x18	62	140	45	210	136	35.7	69.85	M12x20	41.5

10. Installation, operating and maintenance instructions

10.1 Filter installation

When installing filter make sure that sufficient space is available to remove filter element and filter housing.

Preferably the filter should be installed with the filter housing pointing downwards.

The maintenance indicator must be visible.

10.2 Connecting the electrical maintenance indicator

The electrical indicator is connected via a 2-pole appliance plug according to DIN EN 175301-803 with poles marked 1 and 2. The electrical section can be inverted to change from normally open to normally closed position or vice versa.

10.3 When should the filter element be replaced?

1. Filters equipped with visual and electrical maintenance indicator:
During cold starts, the indicator may give a warning signal. Press the red button of the visual indicator once again only after operating temperature has been reached. If the red button immediately pops up again and/or the electrical signal has not switched off after reaching operating temperature the filter element must be replaced after the end of the shift.
2. Please always ensure that you have original Filtration Group spare elements in stock: Disposable elements (PS) cannot be cleaned.

10.4 Element replacement

Note: Elements may only be replaced by people who are familiar with the function of the filter. When replacing elements, appropriate safety clothing (protective goggles, gloves, safety shoes) must be worn.

Note: The maintenance indicator monitors the filter side in operation, which is identified by the position of the switching lever catch. The change-over transfer valve must be switched prior filter servicing. Now the signal of the maintenance indicators cancelled and the red button can be repressed again.

1. Operate and hold pressure equalizing lever located behind switching lever. Pull catch knob and swivel switching lever. Engage the catch on the clear filter side. Place through or drip pan underneath to collect leaving oil.
2. Loosen vent screw of the filter side not in use by 2-3 turns; max. until contact is made with the safety stop.
3. Unscrew filter housing by rotating same counter-clockwise and clean with a suitable medium.
Warning: The shift lever may not, from now until the screwing back in of the filter housing (7.), be activated under any circumstances!
4. Remove filter element with a side-to-side motion.
5. Check O-ring on the filter house for damage. Replace, if necessary.
6. Make sure that the order number on the spare element corresponds to the order number of the filter name-plate.
7. Lightly lubricate the threads of the filter housing and screw into the filter head. Maximum tightening torque for NG 50 to 110 = 60 Nm, for NG 150 to 450 = 100 Nm.
8. To refill the filter chamber, operate only the pressure equalizing lever (leave the switching lever arrested in its catch) long enough for the medium to emerge bubble-free from the vent bore.
9. Tighten vent screw. Check filter for leaks by operating the pressure equalizing lever once again.

11. Spare parts list

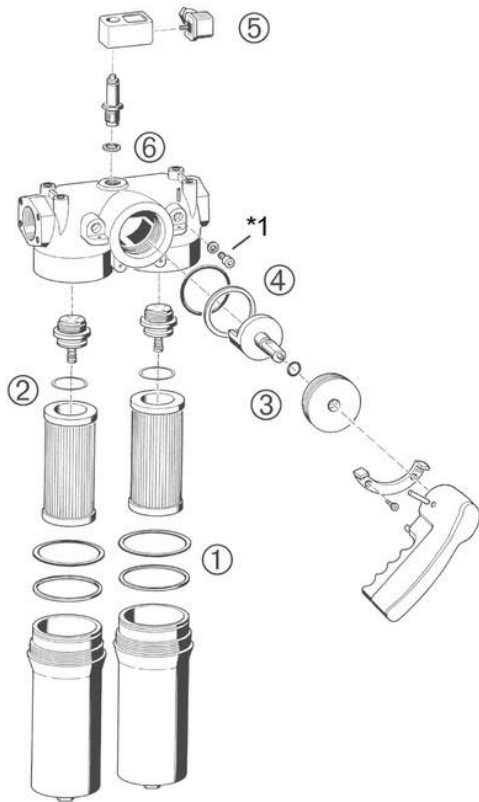

*1 vent screw

Order numbers for spare parts		
Position	Type	Order numbers
① bis ④	Seal kit	
	Pi 3705 - Pi 3711	
	NBR	78305062
	FPM	78305054
	EPDM	78305047
	Pi 3715 - Pi 3745	
	NBR	79375056
	FPM	79375064
	EPDM	79375072
⑤	Maintenance indicator	
	Visual PiS 3093/5	77669914
	Electrical PiS 3092/5	77669864
	Electrical upper section only	77536550
⑥	Seal kit for maintenance indicator	
	NBR	77760275
	FPM	77760283
	EPDM	77760291